



 Read this manual carefully before operating this vehicle.

**OWNER'S MANUAL**

**Neo's**

**YN50 / YN50M**

**5C2-F8199-E3**

 **Read this manual carefully before operating this vehicle. This manual should stay with this vehicle if it is sold.**

Welcome to the Yamaha world of motorcycling!

As the owner of the YN50 / YN50M, you are benefiting from Yamaha's vast experience and newest technology regarding the design and manufacture of high-quality products, which have earned Yamaha a reputation for dependability. Please take the time to read this manual thoroughly, so as to enjoy all advantages of your YN50 / YN50M. The Owner's Manual does not only instruct you in how to operate, inspect and maintain your scooter, but also in how to safeguard yourself and others from trouble and injury.

In addition, the many tips given in this manual will help keep your scooter in the best possible condition. If you have any further questions, do not hesitate to contact your Yamaha dealer.

The Yamaha team wishes you many safe and pleasant rides. So, remember to put safety first!

Yamaha continually seeks advancements in product design and quality. Therefore, while this manual contains the most current product information available at the time of printing, there may be minor discrepancies between your scooter and this manual. If there is any question concerning this manual, please consult a Yamaha dealer.



---

**Please read this manual carefully and completely before operating this scooter.**





---

# IMPORTANT MANUAL INFORMATION

---

EAU10132

Particularly important information is distinguished in this manual by the following notations:

	<p><b>This is the safety alert symbol. It is used to alert you to potential personal injury hazards. Obey all safety messages that follow this symbol to avoid possible injury or death.</b></p>
	<p><b>A WARNING indicates a hazardous situation which, if not avoided, could result in death or serious injury.</b></p>
	<p><b>A NOTICE indicates special precautions that must be taken to avoid damage to the vehicle or other property.</b></p>
	<p><b>A TIP provides key information to make procedures easier or clearer.</b></p>

# IMPORTANT MANUAL INFORMATION

---

EAUS1172

**YN50 / YN50M  
OWNER'S MANUAL  
©2010 by YAMAHA MOTOR ESPAÑA S.A.  
1st edition, July 2010  
All rights reserved.  
Any reprinting or unauthorized use  
without the written permission of  
YAMAHA MOTOR ESPAÑA S.A.  
is expressly prohibited.  
Printed in Spain.**

# TABLE OF CONTENTS

---

<b>SAFETY INFORMATION</b> .....1-1	<b>OPERATION AND IMPORTANT</b>	Checking the front brake pads
Further safe-riding points .....1-5	<b>RIDING POINTS</b> .....5-1	and rear brake shoes .....6-13
<b>DESCRIPTION</b> .....2-1	Starting a cold engine .....5-1	Checking the brake fluid level .....6-14
Left view .....2-1	Starting off .....5-1	Changing the brake fluid .....6-15
Right view .....2-2	Acceleration and deceleration .....5-2	Checking and lubricating the
Controls and instruments .....2-3	Braking.....5-2	cables .....6-15
<b>INSTRUMENT AND CONTROL</b>	Tips for reducing fuel	Checking and lubricating the
<b>FUNCTIONS</b> .....3-1	consumption.....5-3	throttle grip and cable.....6-16
Main switch/steering lock.....3-1	Engine break-in.....5-3	Adjusting the Autolube pump.....6-16
Indicator and warning lights .....3-2	Parking.....5-4	Lubricating the front and rear
Multi-function display .....3-3	<b>PERIODIC MAINTENANCE AND</b>	brake levers .....6-16
Handlebar switches .....3-5	<b>ADJUSTMENT</b> .....6-1	Checking and lubricating the
Front brake lever.....3-6	Periodic maintenance chart for the	centerstand .....6-17
Rear brake lever.....3-6	emission control system .....6-2	Checking the front fork.....6-17
Fuel and 2-stroke engine oil tank	General maintenance and	Checking the steering.....6-18
caps.....3-7	lubrication chart .....6-3	Checking the wheel bearings .....6-18
Fuel .....3-8	Removing and installing the	Battery .....6-19
Fuel tank breather/overflow	cowling and panel .....6-6	Replacing the fuse.....6-20
hose.....3-9	Checking the spark plug .....6-7	Replacing the headlight bulb.....6-21
Catalytic converter.....3-9	Final transmission oil .....6-8	Replacing a front turn signal light
2-stroke engine oil .....3-10	Air filter element.....6-9	bulb .....6-22
Kickstarter.....3-10	Adjusting the carburetor .....6-10	Replacing a turn signal light bulb
Seat.....3-10	Checking the throttle grip	or the tail/brake light bulb .....6-23
Storage compartment.....3-11	free play.....6-10	Replacing the license plate light
Luggage hook.....3-12	Tires .....6-10	bulb (Depens on models) .....6-24
<b>FOR YOUR SAFETY –</b>	Cast wheels .....6-12	Replacing the auxiliary light bulb
<b>PRE-OPERATION CHECKS</b> .....4-1	Checking the front brake lever	(Depens on models) .....6-24
	free play.....6-12	Troubleshooting .....6-25
	Adjusting the rear brake lever	Troubleshooting chart .....6-26
	free play.....6-13	

# TABLE OF CONTENTS

---

---

**SCOOTER CARE AND STORAGE.....7-1**

Matte color caution.....7-1

Care .....7-1

Storage .....7-3

**SPECIFICATIONS .....8-1**

**CONSUMER INFORMATION .....9-1**

Identification numbers .....9-1



# SAFETY INFORMATION

1

## Be a Responsible Owner

As the vehicle's owner, you are responsible for the safe and proper operation of your scooter.

Scooters are single-track vehicles.

Their safe use and operation are dependent upon the use of proper riding techniques as well as the expertise of the operator. Every operator should know the following requirements before riding this scooter.

He or she should:

- Obtain thorough instructions from a competent source on all aspects of scooter operation.
- Observe the warnings and maintenance requirements in this Owner's Manual.
- Obtain qualified training in safe and proper riding techniques.
- Obtain professional technical service as indicated in this Owner's Manual and/or when made necessary by mechanical conditions.

EAUT1016

## Safe Riding

Perform the pre-operation checks each time you use the vehicle to make sure it is in safe operating condition. Failure to inspect or maintain the vehicle properly increases the possibility of an accident or equipment damage. See page 4-1 for a list of pre-operation checks.

- This scooter is designed to carry the operator and a passenger.

## TIP

Although this scooter is designed to carry a passenger, always comply with the local regulations.

- The failure of motorists to detect and recognize scooters in traffic is the predominating cause of automobile/scooter accidents. Many accidents have been caused by an automobile driver who did not see the scooter. Making yourself conspicuous appears to be very effective in reducing the chance of this type of accident.

### Therefore:

- Wear a brightly colored jacket.

- Use extra caution when you are approaching and passing through intersections, since intersections are the most likely places for scooter accidents to occur.
- Ride where other motorists can see you. Avoid riding in another motorist's blind spot.
- Many accidents involve inexperienced operators. In fact, many operators who have been involved in accidents do not even have a current driver's license.
- Make sure that you are qualified and that you only lend your scooter to other qualified operators.
- Know your skills and limits. Staying within your limits may help you to avoid an accident.
- We recommend that you practice riding your scooter where there is no traffic until you have become thoroughly familiar with the scooter and all of its controls.
- Many accidents have been caused by error of the scooter operator.





rator. A typical error made by the operator is veering wide on a turn due to excessive speed or undercornering (insufficient lean angle for the speed).

- Always obey the speed limit and never travel faster than warranted by road and traffic conditions.
- Always signal before turning or changing lanes. Make sure that other motorists can see you.
- The posture of the operator and passenger is important for proper control.
- The operator should keep both hands on the handlebar and both feet on the operator footrests during operation to maintain control of the scooter.
- The passenger should always hold onto the operator, the seat strap or grab bar, if equipped, with both hands and keep both feet on the passenger footrests. Never carry a passenger unless he or she can firmly place both feet on the passenger footrests.

- Never ride under the influence of alcohol or other drugs.
- This scooter is designed for on-road use only. It is not suitable for off-road use.

### Protective apparel

The majority of fatalities from scooter accidents are the result of head injuries. The use of a safety helmet is the single most critical factor in the prevention or reduction of head injuries.

- Always wear an approved helmet.
- Wear a face shield or goggles. Wind in your unprotected eyes could contribute to an impairment of vision that could delay seeing a hazard.
- The use of a jacket, substantial shoes, trousers, gloves, etc., is effective in preventing or reducing abrasions or lacerations.
- Never wear loose-fitting clothes, otherwise they could catch on the control levers or wheels and cause injury or an accident.
- Always wear protective clothing that covers your legs, ankles, and

feet. The engine or exhaust system become very hot during or after operation and can cause burns.

- A passenger should also observe the above precautions.

### Avoid Carbon Monoxide Poisoning

All engine exhaust contains carbon monoxide, a deadly gas. Breathing carbon monoxide can cause headaches, dizziness, drowsiness, nausea, confusion, and eventually death.

Carbon Monoxide is a colorless, odorless, tasteless gas which may be present even if you do not see or smell any engine exhaust. Deadly levels of carbon monoxide can collect rapidly and you can quickly be overcome and unable to save yourself. Also, deadly levels of carbon monoxide can linger for hours or days in enclosed or poorly ventilated areas. If you experience any symptoms of carbon monoxide poisoning, leave the area immediately, get fresh air, and **SEEK MEDICAL TREATMENT.**

- Do not run engine indoors. Even if you try to ventilate engine

# SAFETY INFORMATION

1

exhaust with fans or open windows and doors, carbon monoxide can rapidly reach dangerous levels.

- Do not run engine in poorly ventilated or partially enclosed areas such as barns, garages, or carports.
- Do not run engine outdoors where engine exhaust can be drawn into a building through openings such as windows and doors.

## Loading

Adding accessories or cargo to your scooter can adversely affect stability and handling if the weight distribution of the scooter is changed. To avoid the possibility of an accident, use extreme caution when adding cargo or accessories to your scooter. Use extra care when riding a scooter that has added cargo or accessories. Here, along with the information about accessories below, are some general guidelines to follow if loading cargo to your scooter:

The total weight of the operator, passenger, accessories and cargo must

not exceed the maximum load limit.

**Operation of an overloaded vehicle could cause an accident.**

<b>Maximum load:</b> 163 kg (359 lb)
---

When loading within this weight limit, keep the following in mind:

- Cargo and accessory weight should be kept as low and close to the scooter as possible. Securely pack your heaviest items as close to the center of the vehicle as possible and make sure to distribute the weight as evenly as possible on both sides of the scooter to minimize imbalance or instability.
- Shifting weights can create a sudden imbalance. Make sure that accessories and cargo are securely attached to the scooter before riding. Check accessory mounts and cargo restraints frequently.
  - Properly adjust the suspension for your load (suspension-

adjustable models only), and check the condition and pressure of your tires.

- Never attach any large or heavy items to the handlebar, front fork, or front fender. Such items can create unstable handling or a slow steering response.
- **This vehicle is not designed to pull a trailer or to be attached to a sidecar.**

## Genuine Yamaha Accessories

Choosing accessories for your vehicle is an important decision. Genuine Yamaha accessories, which are available only from a Yamaha dealer, have been designed, tested, and approved by Yamaha for use on your vehicle.

Many companies with no connection to Yamaha manufacture parts and accessories or offer other modifications for Yamaha vehicles. Yamaha is not in a position to test the products that these aftermarket companies produce. Therefore, Yamaha can neither endorse nor recommend the use of accessories not sold by Yamaha or



modifications not specifically recommended by Yamaha, even if sold and installed by a Yamaha dealer.

## **Aftermarket Parts, Accessories, and Modifications**

While you may find aftermarket products similar in design and quality to genuine Yamaha accessories, recognize that some aftermarket accessories or modifications are not suitable because of potential safety hazards to you or others. Installing aftermarket products or having other modifications performed to your vehicle that change any of the vehicle's design or operation characteristics can put you and others at greater risk of serious injury or death. You are responsible for injuries related to changes in the vehicle.

Keep the following guidelines in mind, as well as those provided under "Loading" when mounting accessories.

- Never install accessories or carry cargo that would impair the performance of your scooter. Carefully inspect the accessory before using it to make sure that it

does not in any way reduce ground clearance or cornering clearance, limit suspension travel, steering travel or control operation, or obscure lights or reflectors.

- Accessories fitted to the handlebar or the front fork area can create instability due to improper weight distribution or aerodynamic changes. If accessories are added to the handlebar or front fork area, they must be as lightweight as possible and should be kept to a minimum.
- Bulky or large accessories may seriously affect the stability of the scooter due to aerodynamic effects. Wind may attempt to lift the scooter, or the scooter may become unstable in cross winds. These accessories may also cause instability when passing or being passed by large vehicles.
- Certain accessories can displace the operator from his or her normal riding position.

This improper position limits the freedom of movement of the operator and may limit control ability, therefore, such accessories are not recommended.

- Use caution when adding electrical accessories. If electrical accessories exceed the capacity of the scooter's electrical system, an electric failure could result, which could cause a dangerous loss of lights or engine power.

## **Aftermarket Tires and Rims**

The tires and rims that came with your scooter were designed to match the performance capabilities and to provide the best combination of handling, braking, and comfort. Other tires, rims, sizes, and combinations may not be appropriate. Refer to page 6-10 for tire specifications and more information on replacing your tires.

## **Transporting the Scooter**

Be sure to observe following instructions before transporting the scooter in another vehicle.



## SAFETY INFORMATION

1

- Remove all loose items from the scooter.
- Point the front wheel straight ahead on the trailer or in the truck bed, and choke it in a rail to prevent movement.
- Secure the scooter with tie-downs or suitable straps that are attached to solid parts of the scooter, such as the frame or upper front fork triple clamp (and not, for example, to rubber-mounted handlebars or turn signals, or parts that could break). Choose the location for the straps carefully so the straps will not rub against painted surfaces during transport.
- The suspension should be compressed somewhat by the tie-downs, if possible, so that the scooter will not bounce excessively during transport.

EAU10372

### Further safe-riding points

- Be sure to signal clearly when making turns.
- Braking can be extremely difficult on a wet road. Avoid hard braking, because the scooter could slide. Apply the brakes slowly when stopping on a wet surface.
- Slow down as you approach a corner or turn. Once you have completed a turn, accelerate slowly.
- Be careful when passing parked cars. A driver might not see you and open a door in your path.
- Railroad crossings, streetcar rails, iron plates on road construction sites, and manhole covers become extremely slippery when wet. Slow down and cross them with caution. Keep the scooter upright, otherwise it could slide out from under you.
- The brake pads could get wet when you wash the scooter. After washing the scooter, check the brakes before riding.

- Always wear a helmet, gloves, trousers (tapered around the cuff and ankle so they do not flap), and a bright colored jacket.
- Do not carry too much luggage on the scooter. An overloaded scooter is unstable. Use a strong cord to secure any luggage to the carrier (if equipped). A loose load will affect the stability of the scooter and could divert your attention from the road. (See page 1-1).

## Left view

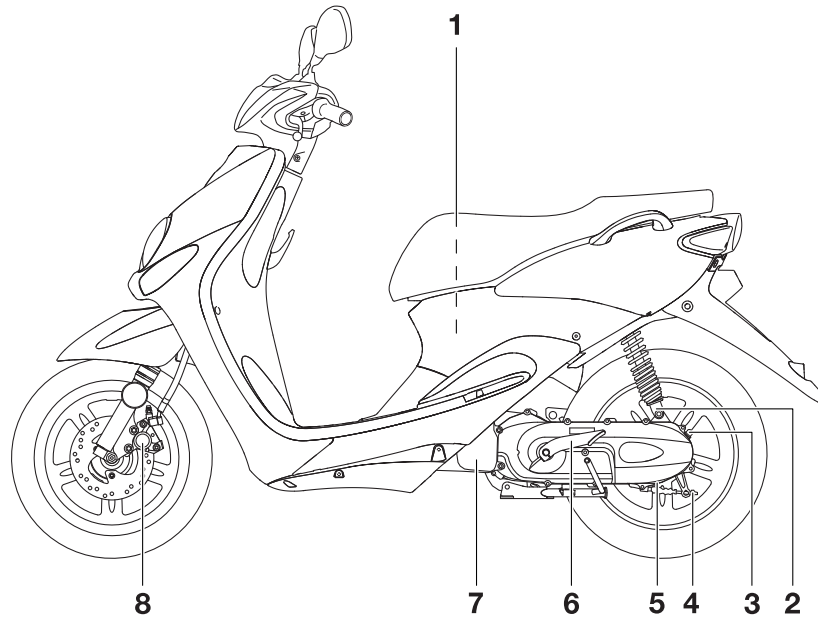

1. Storage compartment (page 3-11)
2. Shock absorber assembly
3. Final transmission oil filler cap (page 6-8)
4. Brake lever free play adjusting nut (page 6-13)
5. Final transmission oil drain bolt (page 6-8)
6. Kickstarter (page 3-10)
7. Air filter element (page 6-9)
8. Front brake pads (page 6-13)

# DESCRIPTION

EAU10420

## Right view

2

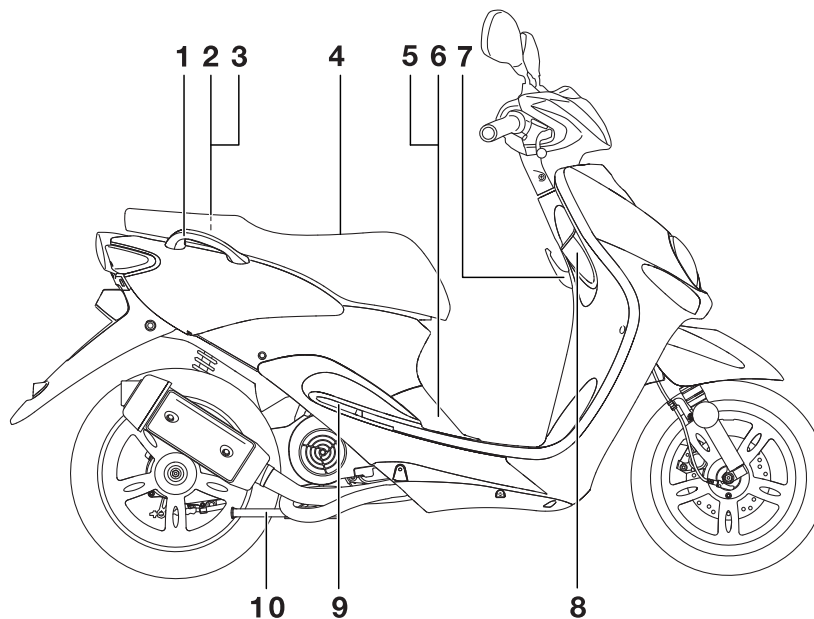

1. Grab bar (page 5-1)
2. Fuel tank cap (page 3-7)
3. 2-stroke engine oil tank (page 3-7/3-10)
4. Seat (page 3-10)
5. Battery (page 6-19)
6. Fuses (page 6-20)
7. Luggage hook (page 3-12)
8. Main switch/steering lock (page 3-1)

9. Passenger footrest
10. Centerstand (page 6-17)

## Controls and instruments

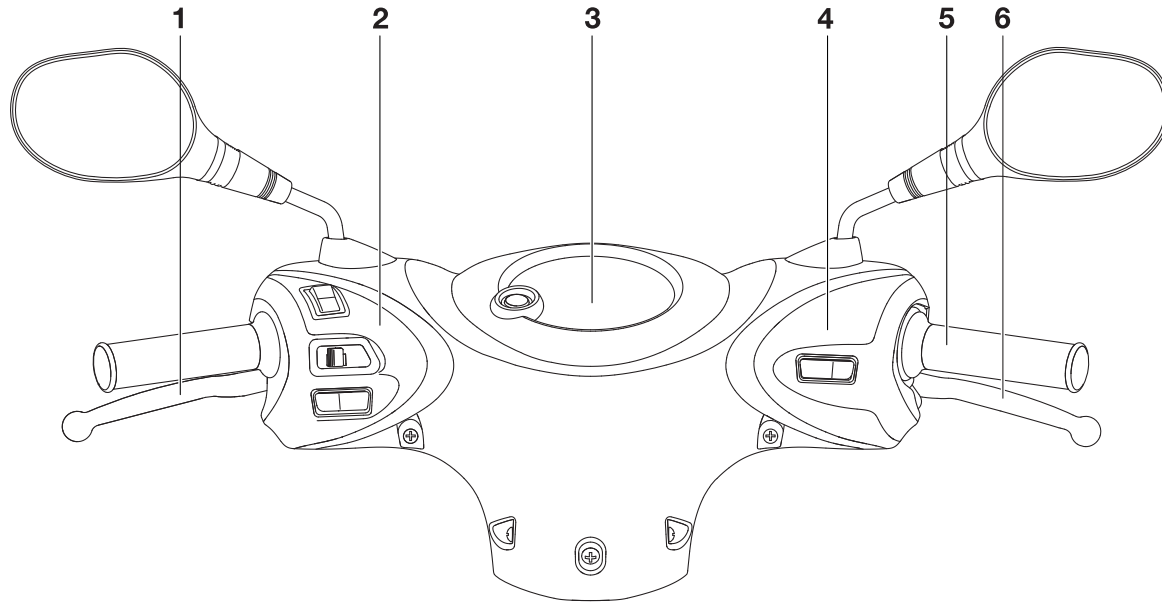

1. Rear brake lever (page 3-6)
2. Left handlebar switches (page 3-5)
3. Multi-function display (page 3-3)
4. Right handlebar switch (page 3-5)
5. Throttle grip (page 6-10)
6. Front brake lever (page 3-6)

# INSTRUMENT AND CONTROL FUNCTIONS

3

## Main switch/steering lock

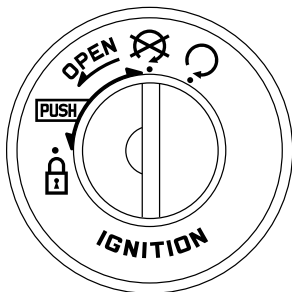

EAU10460

The main switch/steering lock controls the ignition and lighting systems, and is used to lock the steering. The various positions are described below.

### ON “”

EAUS1381

All electrical circuits are supplied with power, the meter lighting comes on, and the engine can be started. The key cannot be removed.

### TIP

The headlight and taillight come on automatically when the engine is started.



EAU47791

### OFF “”

All electrical systems are off. The key can be removed.

EWA15350



**WARNING**  
Never turn the key to “” or “” while the vehicle is moving. Otherwise the electrical systems will be switched off, which may result in loss of control or an accident.

EAU10681



### LOCK “”

The steering is locked, and all electrical systems are off. The key can be removed.

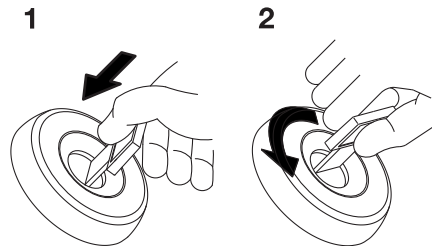
### To lock the steering



1. Push
2. Turn

1. Turn the handlebars all the way to the left.
2. Push the key in from the “” position, and then turn it to “” while still pushing it.
3. Remove the key.

### To unlock the steering

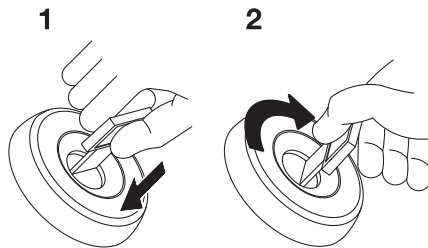

1. Push
2. Turn

Push the key in, and then turn it to “” while still pushing it.







# INSTRUMENT AND CONTROL FUNCTIONS

EAU11004

## Indicator and warning lights



1. 2-stroke engine oil level warning light “”
2. High beam indicator light “”
3. Turn signal indicator light “”
4. Fuel level warning indicator “”

EAU11020

## Turn signal indicator light “”

This indicator light flashes when the turn signal switch is pushed to the left or right.

EAU11080

## High beam indicator light “”

This indicator light comes on when the high beam of the headlight is switched on.

EAU1062

## Oil level warning light “”

This warning light comes on when the key is in the “” position or if the oil level in the 2-stroke engine oil tank is low during operation. If the warning light comes on during operation, stop immediately and fill the oil tank with 2-stroke engine oil of either JASO grade “FC” or ISO grades “EG-C” or “EG-D”. The warning light should go off after the 2-stroke engine oil tank has been refilled.

### TIP

If the warning light does not come on when the key is in the “” position or does not go off after the 2-stroke engine oil tank has been refilled, have a Yamaha dealer check the electrical circuit.

ECA16291

### NOTICE

**Do not operate the vehicle until you know that the engine oil level is sufficient.**

EAU11352

## Fuel level warning light “”

This warning light comes on when the fuel level drops below approximately 1.4 L (0.37 US gal, 0.31 Imp.gal). When this occurs, refuel as soon as possible.

The electrical circuit of the warning light can be checked by turning the key to “”. The warning light should come on for a few seconds, and then go off.

If the warning light does not come on initially when the key is turned to “”, or if the warning light remains on, have a Yamaha dealer check the electrical circuit.

# INSTRUMENT AND CONTROL FUNCTIONS

## Multi-function display

EAUS1394

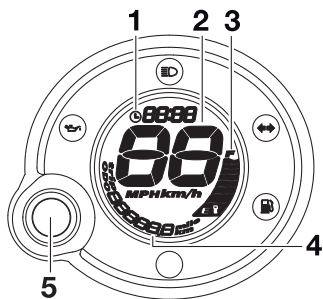

1. Clock
2. Speedometer
3. Fuel gauge
4. Odometer/tripmeter/fuel reserve tripmeter
5. "RESET/SELECT" button

### TIP

The multi-function display performs the following self-test for three seconds in order to check the electrical circuit.

- The speedometer digits display from 0 to 99, and then from 99 to 0 in kilometers. If the speedometer is set to miles, the digits display from 0 to 65, and then from 65 to 0.

- All LCD segments and warning lights come on and then go off.

EWA12312

### WARNING

**Be sure to stop the vehicle before making any setting changes to the multi-function display. Changing settings while riding can distract the operator and increase the risk of an accident.**

The multi-function display is equipped with the following:

- a digital clock
- a digital speedometer (which shows riding speed)
- an odometer (which shows the total distance traveled)
- a tripmeter (which shows the distance traveled since it was last set to zero)
- a fuel reserve tripmeter (which shows the distance traveled on the fuel reserve)
- a fuel gauge
- a self-diagnosis device

### TIP

- Be sure to turn the key to "⊙" before using the button.
- For the U.K. only: To switch the speedometer and odometer/tripmeter displays between kilometers and miles, when the main switch is turned to "⊙", press the button for at least eight seconds.

### To set the clock:

1. Select the odometer and push the button for at least three seconds.
2. When the hour digits start flashing, push the button to set the hours.

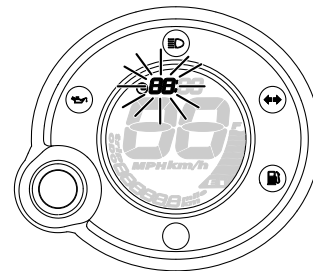

# INSTRUMENT AND CONTROL FUNCTIONS

- To change the minutes digits, push the button for at least three seconds.
- When the minutes digits start flashing, push the button to set the minutes.

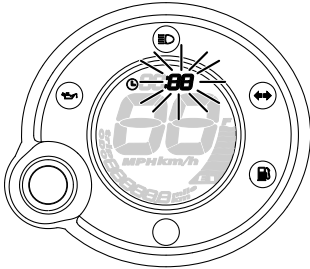

- Push the button for at least three seconds to start the clock.

**TIP** After setting the clock, be sure to push the button for at least three seconds before turning the key to “ $\otimes$ ”, otherwise the clock will not be set.

## Odometer and tripmeter modes

Pushing the button switches the display between the odometer mode “ODO” and the tripmeter “TRIP” in the following order:

ODO → TRIP → ODO

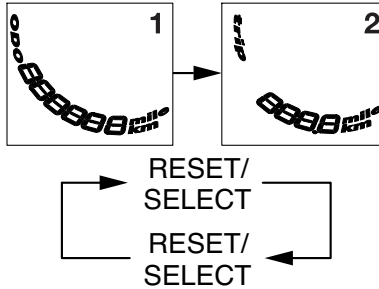

If the fuel level warning indicator comes on (see page 3-2), the odometer display will automatically change to the fuel reserve tripmeter mode “TRIP F” and start counting the distance traveled from that point. In that case, pushing the button switches the display between the various tripmeter and odometer modes in the following order:

TRIP F → ODO → TRIP → TRIP F

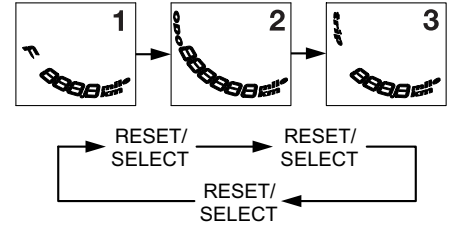

To reset a tripmeter, select it by pushing the button, and then push it again for at least three seconds. If you do not reset the fuel reserve tripmeter manually, it will reset itself automatically and the display will return to the prior mode after refueling and traveling 5 km (3 mi).

**TIP** The display cannot be changed back to “TRIP F” after pushing the button.

## Fuel gauge

The fuel gauge indicates the amount of fuel in the fuel tank. The display segments of the fuel gauge disappear towards “E” (Empty) as the fuel level

# INSTRUMENT AND CONTROL FUNCTIONS

EAU12348

decreases. When only two segments are left near “E”, the fuel level warning indicator comes on. Refuel as soon as possible.

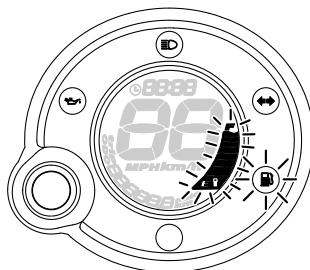
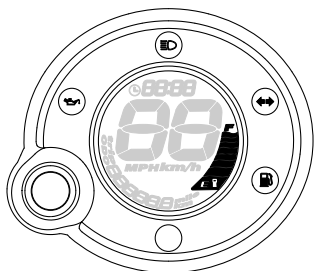

3

## Self-diagnosis device





This model is equipped with a self-diagnosis device for the fuel electrical circuit.

If a problem is detected in the fuel electrical circuit, all LCD segments of the fuel gauge and the fuel level warning indicator will flash. If this occurs, have a Yamaha dealer check the vehicle.

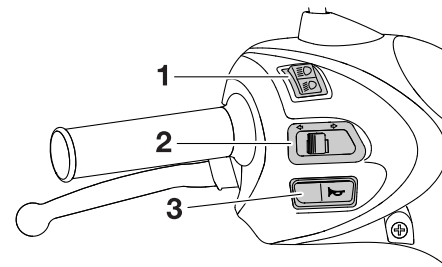
## Handlebar switches

### Left



1. Dimmer switch “ /  ”
2. Turn signal switch “ /  ”
3. Horn switch “ ”

### Right

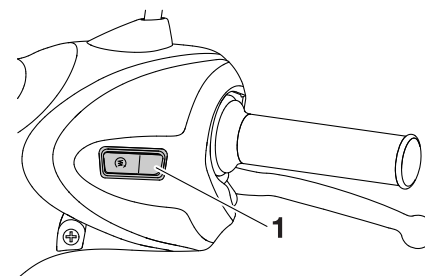



1. Start switch “ ”

# INSTRUMENT AND CONTROL FUNCTIONS



EAU12400

## Dimmer switch “ / ”

Set this switch to “ ” for the high beam and to “ ” for the low beam.

EAU12460

## Turn signal switch “ / ”

To signal a right-hand turn, push this switch to “ ”. To signal a left-hand turn, push this switch to “ ”. When released, the switch returns to the center position. To cancel the turn signal lights, push the switch in after it has returned to the center position.

EAU12500

## Horn switch “ ”

Press this switch to sound the horn.

EAUM1132

## Start switch “ ”

Push this switch while applying the front or rear brake to crank the engine with the starter. See page 5-1 for starting instructions prior to starting the engine.

EAU12900

## Front brake lever

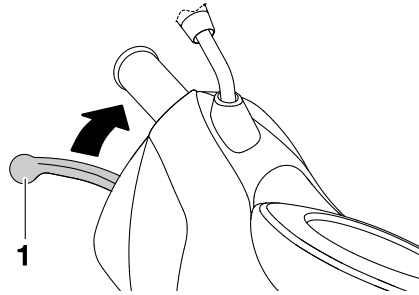

1. Front brake lever

The front brake lever is located on the right handlebar grip. To apply the front brake, pull this lever toward the handlebar grip.

EAU12950

## Rear brake lever

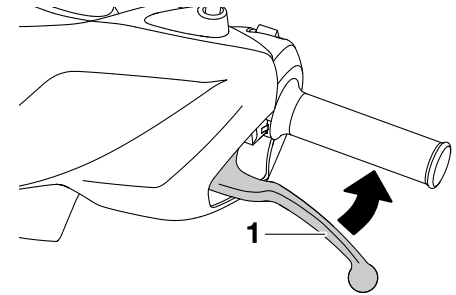

1. Rear brake lever

The rear brake lever is located on the left handlebar grip. To apply the rear brake, pull this lever toward the handlebar grip.

# INSTRUMENT AND CONTROL FUNCTIONS

EAU13202

## Fuel and 2-stroke engine oil tank caps

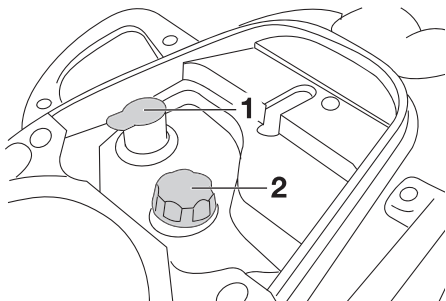

1. 2-stroke engine oil tank cap
2. Fuel tank cap

The fuel tank cap and the 2-stroke engine oil tank cap are located under the seat. (See page 3-10).

## Fuel tank cap

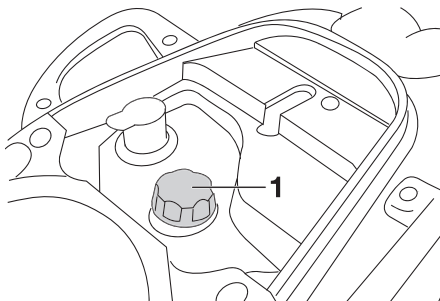

1. Fuel tank cap

To remove the fuel tank cap, turn it counterclockwise, and then pull it off. To install the fuel tank cap, turn it clockwise.

## 2-stroke engine oil tank cap

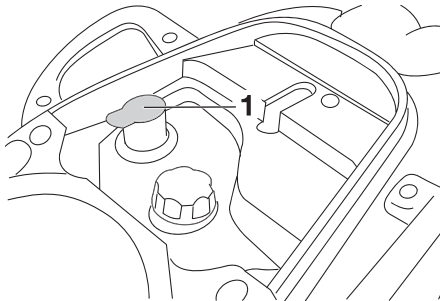

1. 2-stroke engine oil tank cap

To remove the 2-stroke engine oil tank cap, pull it off.

To install the 2-stroke engine oil tank cap, push it into the oil tank opening.

EWA10141

## **WARNING**

**Make sure that the fuel and 2-stroke engine oil tank caps are properly installed before riding the scooter. Leaking fuel is a fire hazard.**

# INSTRUMENT AND CONTROL FUNCTIONS

## Fuel

Make sure there is sufficient gasoline in the tank.

EAU13221

EWA10881



**WARNING**

**Gasoline and gasoline vapors are extremely flammable. To avoid fires and explosions and to reduce the risk of injury when refueling, follow these instructions.**

1. Before refueling, turn off the engine and be sure that no one is sitting on the vehicle. Never refuel while smoking, or while in the vicinity of sparks, open flames, or other sources of ignition such as the pilot lights of water heaters and clothes dryers.
2. Do not overfill the fuel tank. When refueling, be sure to insert the pump nozzle into the fuel tank filler hole. Stop filling when the fuel reaches the bottom of the filler tube. Because fuel expands when it heats up, heat from the engine or the sun can cause fuel to spill out of the fuel tank.

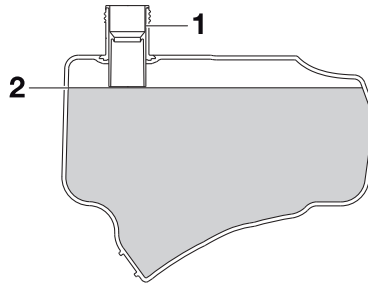

1. Fuel tank filler hole
2. Maximum fuel level

3. Wipe up any spilled fuel immediately. **NOTICE: Immediately wipe off spilled fuel with a clean, dry, soft cloth, since fuel may deteriorate painted surfaces or plastic parts.** [ECA10071]
4. Be sure to securely close the fuel tank cap.

EWA15151



**WARNING**

**Gasoline is poisonous and can cause injury or death. Handle gasoline with care. Never siphon gasoline by mouth. If you should swallow some gasoline or inhale a lot of gasoline vapor, or get some gasoline in your**

**eyes, see your doctor immediately. If gasoline spills on your skin, wash with soap and water. If gasoline spills on your clothing, change your clothes.**

EAU13270

**Recommended fuel:**  
REGULAR UNLEADED  
GASOLINE ONLY

**Fuel tank capacity:**

6.1 L (1.61 US gal, 1.34 Imp.gal)

**Fuel reserve amount:**

1.4 L (0.37 US gal, 0.31 Imp.gal)

Your Yamaha engine has been designed to use regular unleaded gasoline with a research octane number of 91 or higher. If knocking (or pinging) occurs, use a gasoline of a different brand or premium unleaded fuel. Use of unleaded fuel will extend spark plug life and reduce maintenance costs.

# INSTRUMENT AND CONTROL FUNCTIONS

EAU39451

## Fuel tank breather/overflow hose

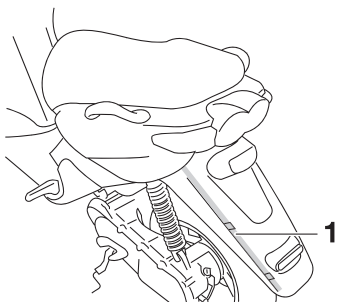

1. Fuel tank breather/overflow hose

Before operating the motorcycle:

- Check the fuel tank breather/overflow hose connection.
- Check the fuel tank breather/overflow hose for cracks or damage, and replace it if damaged.
- Make sure that the end of the fuel tank breather/overflow hose is not blocked, and clean it if necessary.

EAU13433

## Catalytic converter

This model is equipped with a catalytic converter in the exhaust system.

EWA10862

### WARNING

The exhaust system is hot after operation. To prevent a fire hazard or burns:

- Do not park the vehicle near possible fire hazards such as grass or other materials that easily burn.
- Park the vehicle in a place where pedestrians or children are not likely to touch the hot exhaust system.
- Make sure that the exhaust system has cooled down before doing any maintenance work.
- Do not allow the engine to idle more than a few minutes. Long idling can cause a build-up of heat.

ECA10701

### NOTICE

Use only unleaded gasoline. The use of leaded gasoline will cause unrepairable damage to the catalytic converter.



EAUM1150

## 2-stroke engine oil

Make sure that there is sufficient oil in the 2-stroke engine oil tank. Add the recommended 2-stroke engine oil if necessary.

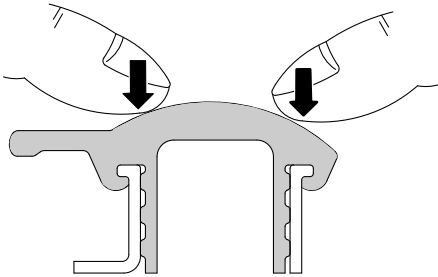

### TIP

Make sure that the 2-stroke engine oil tank cap is properly installed.

#### Recommended oil:

2-stroke engine oil (JASO grade "FC", or ISO grades "EG-C" or "EG-D")

#### Oil quantity:

1.50 L (1.59 US qt, 1.32 Imp.qt)

EAUS1050

## Kickstarter

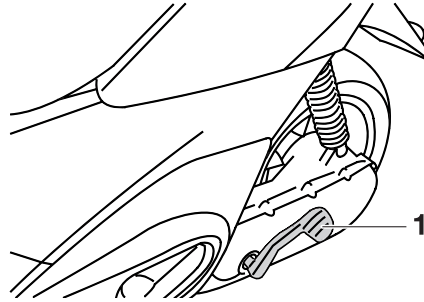

1. Kickstarter lever

To start the engine, push the kickstarter down lightly with your foot until the gears engage, and then push it down smoothly but forcefully.

EAU13932

## Seat

### To open the seat

1. Place the scooter on the centers-stand.
2. Insert the key into the main switch, and then turn it counter-clockwise to "OPEN".

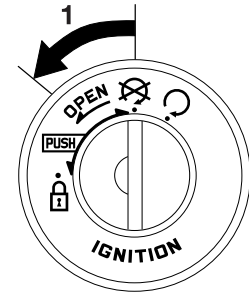

1. Open

### TIP

Do not push inward when turning the key.

3. Fold the seat up.

# INSTRUMENT AND CONTROL FUNCTIONS

EAUM1191

ECA10080

3

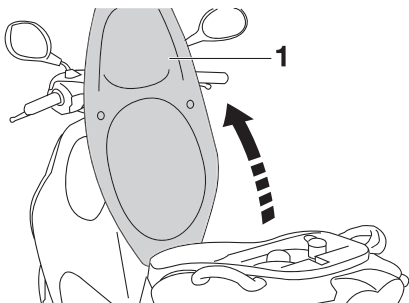

1. Seat open position

## To close the seat

1. Fold the seat down, and then push it down to lock it in place.
2. Remove the key from the main switch if the scooter will be left unattended.

## TIP

Make sure that the seat is properly secured before riding.

## Storage compartment

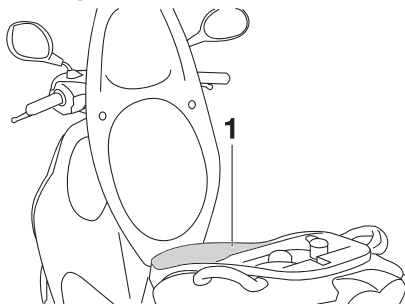

1. Storage compartment

There is a storage compartment under the seat. (See page 3-10).

EWA10961

## WARNING

- Do not exceed the load limit of 5 kg (11.0 lb) for the storage compartment.
- Do not exceed the maximum load of 163 kg (359 lb) for the vehicle.

## NOTICE

Keep the following points in mind when using the storage compartment.

- Since the storage compartment accumulates heat when exposed to the sun, do not store anything susceptible to heat inside it.
- To avoid humidity from spreading through the storage compartment, wrap wet articles in a plastic bag before storing them in the compartment.
- Since the storage compartment may get wet while the scooter is being washed, wrap any articles stored in the compartment in a plastic bag.
- Do not keep anything valuable or breakable in the storage compartment.

To store a helmet in the storage compartment, place the helmet with the front facing backward.

# INSTRUMENT AND CONTROL FUNCTIONS

## TIP

- Some helmets cannot be stored in the storage compartment because of their size or shape.
- Do not leave your scooter unattended with the seat open.

EAUT1072

## Luggage hook

EWAT1031

### **! WARNING**

- Do not exceed the load limit of 3 kg (6.6 lb) for the luggage hook.
- Do not exceed the maximum load of 163 kg (369 lb) for the vehicle.

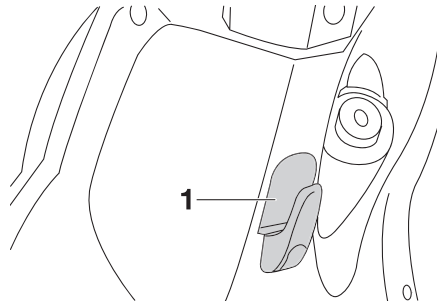

1. Luggage hook

# FOR YOUR SAFETY – PRE-OPERATION CHECKS

EAU15596

Inspect your vehicle each time you use it to make sure the vehicle is in safe operating condition. Always follow the inspection and maintenance procedures and schedules described in the Owner's Manual.

EWA11151

## **WARNING**

Failure to inspect or maintain the vehicle properly increases the possibility of an accident or equipment damage. Do not operate the vehicle if you find any problem. If a problem cannot be corrected by the procedures provided in this manual, have the vehicle inspected by a Yamaha dealer.

Before using this vehicle, check the following points:

4

ITEM	CHECKS	PAGE
Fuel	<ul style="list-style-type: none"><li>• Check fuel level in fuel tank.</li><li>• Refuel if necessary.</li><li>• Check fuel line for leakage.</li></ul>	3-8
2-stroke engine oil	<ul style="list-style-type: none"><li>• Check oil level in oil tank.</li><li>• If necessary, add recommended oil to specified level.</li><li>• Check vehicle for oil leakage.</li></ul>	3-10
Final transmission oil	<ul style="list-style-type: none"><li>• Check vehicle for oil leakage.</li></ul>	6-8
Front brake	<ul style="list-style-type: none"><li>• Check operation.</li><li>• If soft or spongy, have Yamaha dealer bleed hydraulic system.</li><li>• Check brake pads for wear.</li><li>• Replace if necessary.</li><li>• Check fluid level in reservoir.</li><li>• If necessary, add recommended brake fluid to specified level.</li><li>• Check hydraulic system for leakage.</li></ul>	6-13, 6-14
Rear brake	<ul style="list-style-type: none"><li>• Check operation.</li><li>• Lubricate cable if necessary.</li><li>• Check lever free play.</li><li>• Adjust if necessary.</li></ul>	6-13

# FOR YOUR SAFETY – PRE-OPERATION CHECKS

ITEM	CHECKS	PAGE
<b>Throttle grip</b>	<ul style="list-style-type: none"> <li>• Make sure that operation is smooth.</li> <li>• Check throttle grip free play.</li> <li>• If necessary, have Yamaha dealer adjust throttle grip free play and lubricate cable and grip housing.</li> </ul>	6-10, 6-16
<b>Wheels and tires</b>	<ul style="list-style-type: none"> <li>• Check for damage.</li> <li>• Check tire condition and tread depth.</li> <li>• Check air pressure.</li> <li>• Correct if necessary.</li> </ul>	6-10, 6-12
<b>Brake levers</b>	<ul style="list-style-type: none"> <li>• Make sure that operation is smooth.</li> <li>• Lubricate lever pivoting points if necessary.</li> </ul>	6-16
<b>Centerstand</b>	<ul style="list-style-type: none"> <li>• Make sure that operation is smooth.</li> <li>• Lubricate pivot if necessary.</li> </ul>	6-17
<b>Chassis fasteners</b>	<ul style="list-style-type: none"> <li>• Make sure that all nuts, bolts and screws are properly tightened.</li> <li>• Tighten if necessary.</li> </ul>	—
<b>Instruments, lights, signals and switches</b>	<ul style="list-style-type: none"> <li>• Check operation.</li> <li>• Correct if necessary.</li> </ul>	—
<b>Battery</b>	<ul style="list-style-type: none"> <li>• Check fluid level.</li> <li>• Fill with distilled water if necessary.</li> </ul>	6-19

# OPERATION AND IMPORTANT RIDING POINTS

EAU15951

Read the Owner's Manual carefully to become familiar with all controls. If there is a control or function you do not understand, ask your Yamaha dealer.

EWA10271

## **WARNING**

Failure to familiarize yourself with the controls can lead to loss of control, which could cause an accident or injury.

5

EAUT1101

## Starting a cold engine

ECA10250

### **NOTICE**

See page 5-3 for engine break-in instructions prior to operating the vehicle for the first time.

1. Turn the key to “”.
2. Close the throttle grip completely.
3. Start the engine by pushing the start switch or by kicking the kickstarter, while applying the front or rear brake. **NOTICE: For maximum engine life, never accelerate hard when the engine is cold!** [ECA11041]
3. If the engine fails to start by pushing the start switch, release the switch, wait a few seconds, and then try again. Each starting attempt should be as short as possible to preserve the battery. Do not crank the engine more than 5 seconds on any one attempt. If the engine does not start with the starter motor, try using the kickstarter.

EAU16770

## Starting off

### **TIP**

Before starting off, allow the engine to warm up.

1. While pulling the rear brake lever with your left hand and holding the carrier with your right hand, push the scooter off the centerstand.

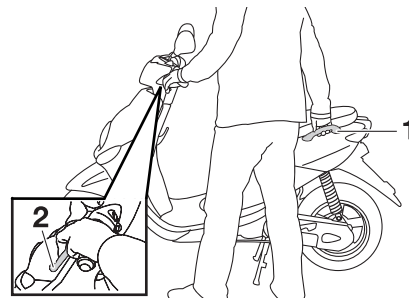

1. Grab bar
2. Rear brake lever

2. Sit astride the seat, and then adjust the rear view mirrors.
3. Switch the turn signal on.

# OPERATION AND IMPORTANT RIDING POINTS

4. Check for oncoming traffic, and then slowly turn the throttle grip (on the right) in order to take off.
5. Switch the turn signal off.

## Acceleration and deceleration

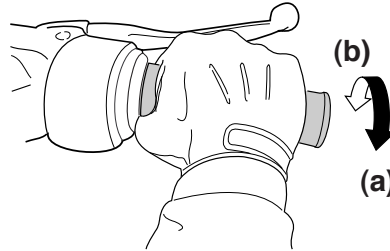

ZAUM0199

The speed can be adjusted by opening and closing the throttle. To increase the speed, turn the throttle grip in direction (a). To reduce the speed, turn the throttle grip in direction (b).

EAU16780

## Braking

EAU16793

EWA10300

### **⚠ WARNING**

- Avoid braking hard or suddenly (especially when leaning over to one side), otherwise the scooter may skid or overturn.
- Railroad crossings, streetcar rails, iron plates on road construction sites, and manhole covers become extremely slippery when wet. Therefore, slow down when approaching such areas and cross them with caution.
- Keep in mind that braking on a wet road is much more difficult.
- Ride slowly down a hill, as braking downhill can be very difficult.

1. Close the throttle completely.
2. Apply both front and rear brakes simultaneously while gradually increasing the pressure.

# OPERATION AND IMPORTANT RIDING POINTS

Front

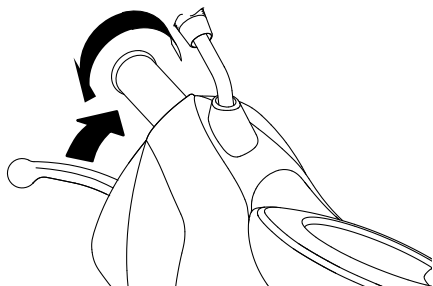

Rear

5

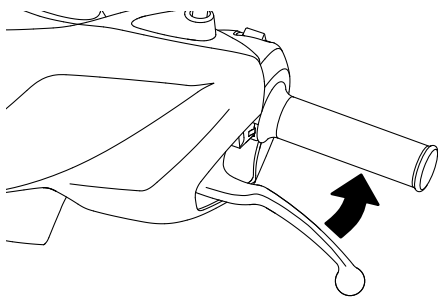

EAU16820

EAU16830

## Tips for reducing fuel consumption

Fuel consumption depends largely on your riding style. Consider the following tips to reduce fuel consumption:

- Avoid high engine speeds during acceleration.
- Avoid high engine speeds with no load on the engine.
- Turn the engine off instead of letting it idle for an extended length of time (e.g., in traffic jams, at traffic lights or at railroad crossings).

## Engine break-in

There is never a more important period in the life of your engine than the period between 0 and 1000 km (600 mi). For this reason, you should read the following material carefully. Since the engine is brand new, do not put an excessive load on it for the first 1000 km (600 mi). The various parts in the engine wear and polish themselves to the correct operating clearances. During this period, prolonged full-throttle operation or any condition that might result in engine overheating must be avoided.

EAUM2091

### 0–150 km (0–90 mi)

- Avoid prolonged operation above 1/3 throttle. Vary the speed of the scooter from time to time. Do not operate it at one set throttle position.

### 150–500 km (90–300 mi)

- Avoid prolonged operation above 1/2 throttle.



# OPERATION AND IMPORTANT RIDING POINTS

## 500–1000 km (300–600 mi)

- Avoid cruising speeds in excess of 3/4 throttle.

## 1000 km (600 mi) and beyond

- Avoid prolonged full throttle operation. Vary speeds occasionally.  
**NOTICE:** After 1000 km (600 mi) of operation, the final transmission oil must be changed. [ECAM1071]

ECA10270

### **NOTICE**

If any engine trouble should occur during the engine break-in period, immediately have a Yamaha dealer check the vehicle.

EAU17213

## Parking

When parking, stop the engine, and then remove the key from the main switch.

EWA10311

### **! WARNING**

- Since the engine and exhaust system can become very hot, park in a place where pedestrians or children are not likely to touch them and be burned.
- Do not park on a slope or on soft ground, otherwise the vehicle may overturn, increasing the risk of a fuel leak and fire.
- Do not park near grass or other flammable materials which might catch fire.

# PERIODIC MAINTENANCE AND ADJUSTMENT

---

EAU17241

Periodic inspection, adjustment, and lubrication will keep your vehicle in the safest and most efficient condition possible. Safety is an obligation of the vehicle owner/operator. The most important points of vehicle inspection, adjustment, and lubrication are explained on the following pages. The intervals given in the periodic maintenance and lubrication chart should be simply considered as a general guide under normal riding conditions. However, depending on the weather, terrain, geographical location, and individual use, the maintenance intervals may need to be shortened.

EWA10321

## **WARNING**

**Failure to properly maintain the vehicle or performing maintenance activities incorrectly may increase your risk of injury or death during service or while using the vehicle. If you are not familiar with vehicle service, have a Yamaha dealer perform service.**

---

EWA15121

## **WARNING**

**Turn off the engine when performing maintenance unless otherwise specified.**

- **A running engine has moving parts that can catch on body parts or clothing and electrical parts that can cause shocks or fires.**
  - **Running the engine while servicing can lead to eye injury, burns, fire, or carbon monoxide poisoning – possibly leading to death. See page 1-1 for more information about carbon monoxide.**
-

# PERIODIC MAINTENANCE AND ADJUSTMENT

EAU46871

## TIP

- The annual checks must be performed every year, except if a kilometer-based maintenance, or for the UK, a mileage-based maintenance, is performed instead.
- From 30000 km (17500 mi), repeat the maintenance intervals starting from 6000 km (3500 mi).
- Items marked with an asterisk should be performed by a Yamaha dealer as they require special tools, data and technical skills.

EAU46920

## Periodic maintenance chart for the emission control system

NO.	ITEM	CHECK OR MAINTENANCE JOB	ODOMETER READING					ANNUAL CHECK
			1000 km (600 mi)	6000 km (3500 mi)	12000 km (7000 mi)	18000 km (10500 mi)	24000 km (14000 mi)	
1	* Fuel line	<ul style="list-style-type: none"> <li>• Check fuel and vacuum hoses for cracks or damage.</li> </ul>		√	√	√	√	√
2	Spark plug	<ul style="list-style-type: none"> <li>• Replace.</li> </ul>		√	√	√	√	√
3	* Carburetor	<ul style="list-style-type: none"> <li>• Adjust engine idling speed.</li> </ul>	√	√	√	√	√	√
4	* Air induction system	<ul style="list-style-type: none"> <li>• Check the air cut-off valve, reed valve, and hose for damage.</li> <li>• Replace any damaged parts if necessary.</li> </ul>		√	√	√	√	√

# PERIODIC MAINTENANCE AND ADJUSTMENT

EAU17717

## General maintenance and lubrication chart

NO.	ITEM	CHECK OR MAINTENANCE JOB	ODOMETER READING					ANNUAL CHECK
			1000 km (600 mi)	6000 km (3500 mi)	12000 km (7000 mi)	18000 km (10500 mi)	24000 km (14000 mi)	
1	* Air filter element	• Clean.		√		√		
		• Replace.			√		√	
2	* Battery	• Check electrolyte level and specific gravity. • Make sure that the breather hose is properly routed.		√	√	√	√	√
3	* Front brake	• Check operation, fluid level and vehicle for fluid leakage.	√	√	√	√	√	√
		• Replace brake pads.		Whenever worn to the limit				
4	* Rear brake	• Check operation and adjust brake lever free play.	√	√	√	√	√	√
		• Replace brake shoes.		Whenever worn to the limit				
5	* Brake hose	• Check for cracks or damage.		√	√	√	√	√
		• Replace.		Every 4 years				
6	* Wheels	• Check runout and for damage.		√	√	√	√	
7	* Tires	• Check tread depth and for damage. • Replace if necessary. • Check air pressure. • Correct if necessary.		√	√	√	√	√
8	* Wheel bearings	• Check bearing for looseness or damage.		√	√	√	√	

6

# PERIODIC MAINTENANCE AND ADJUSTMENT

NO.	ITEM	CHECK OR MAINTENANCE JOB	ODOMETER READING					ANNUAL CHECK
			1000 km (600 mi)	6000 km (3500 mi)	12000 km (7000 mi)	18000 km (10500 mi)	24000 km (14000 mi)	
9	* <b>Steering bearings</b>	• Check bearing play and steering for roughness.	√	√	√	√	√	
		• Lubricate with lithium-soap-based grease.	Every 24000 km (14000 mi)					
10	* <b>Chassis fasteners</b>	• Make sure that all nuts, bolts and screws are properly tightened.		√	√	√	√	√
11	<b>Front brake lever pivot shaft</b>	• Lubricate with silicone grease.		√	√	√	√	√
12	<b>Rear brake lever pivot shaft</b>	• Lubricate with lithium-soap-based grease.		√	√	√	√	√
13	<b>Centerstand</b>	• Check operation. • Lubricate.		√	√	√	√	√
14	* <b>Front fork</b>	• Check operation and for oil leakage.		√	√	√	√	
15	* <b>Shock absorber assembly</b>	• Check operation and shock absorber for oil leakage.		√	√	√	√	
16	* <b>Autolube pump</b>	• Check operation. • Bleed if necessary.	√		√		√	√
17	<b>Final transmission oil</b>	• Check vehicle for oil leakage.	√	√		√		
		• Change.	√		√		√	
18	* <b>V-belt</b>	• Replace.	Every 10000 km (6000 mi)					
19	* <b>Front and rear brake switches</b>	• Check operation.	√	√	√	√	√	√
20	<b>Moving parts and cables</b>	• Lubricate.		√	√	√	√	√

# PERIODIC MAINTENANCE AND ADJUSTMENT

NO.	ITEM	CHECK OR MAINTENANCE JOB	ODOMETER READING					ANNUAL CHECK
			1000 km (600 mi)	6000 km (3500 mi)	12000 km (7000 mi)	18000 km (10500 mi)	24000 km (14000 mi)	
21 *	<b>Throttle grip housing and cable</b>	<ul style="list-style-type: none"> <li>• Check operation and free play.</li> <li>• Adjust the throttle cable free play if necessary.</li> <li>• Lubricate the throttle grip housing and cable.</li> </ul>		√	√	√	√	√
22 *	<b>Lights, signals and switches</b>	<ul style="list-style-type: none"> <li>• Check operation.</li> <li>• Adjust headlight beam.</li> </ul>	√	√	√	√	√	√

EAUM2070

## TIP

6

- The air filter needs more frequent service if you are riding in unusually wet or dusty areas.
- Hydraulic brake service
  - Regularly check and, if necessary, correct the brake fluid level.
  - Every two years change the brake fluid.
  - Replace the brake hoses every four years and if cracked or damaged.

# PERIODIC MAINTENANCE AND ADJUSTMENT

## Removing and installing the cowling and panel

EAU18740

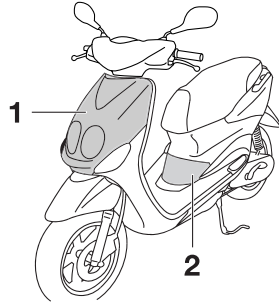

1. Cowling A
2. Panel A

The cowling and panel shown above need to be removed to perform some of the maintenance jobs described in this chapter. Refer to this section each time a cowling or panel needs to be removed and installed.

EAU45470

### Cowling A

#### To remove the cowling

1. Remove the screws, and then pull the cowling off as shown.

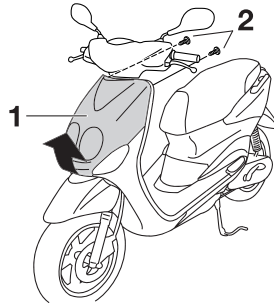

1. Cowling A
2. Screw

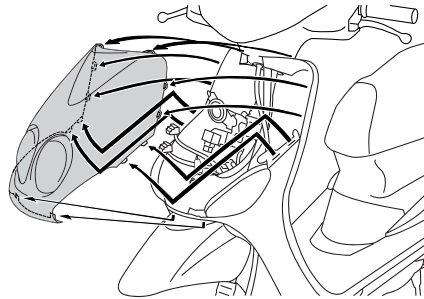

2. Disconnect the headlight coupler, and the auxiliary light lead coupler.

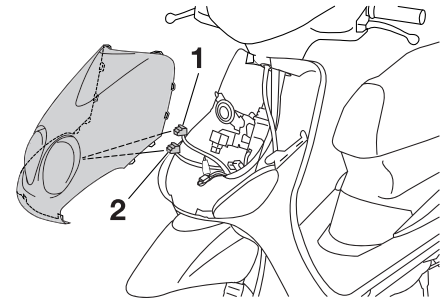

1. Headlight coupler
2. Auxiliary light lead coupler

#### To install the cowling

1. Connect the headlight coupler, and the auxiliary light lead coupler.
2. Place the cowling in the original position, and then install the screws.

EAU19281

### Panel A

#### To remove the panel

Remove the screw, and then pull the panel off as shown.

# PERIODIC MAINTENANCE AND ADJUSTMENT

EAUS1760

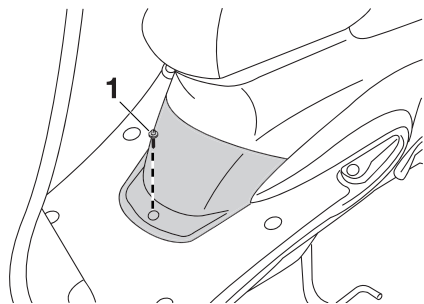

1. Screw

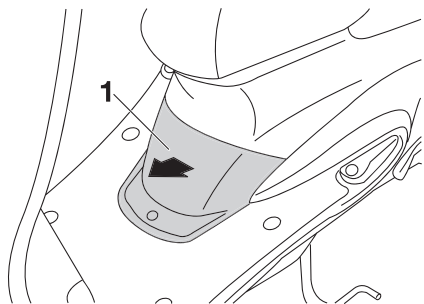

1. Panel A

## To install the panel

Place the panel in the original position, and then install the screw.

## Checking the spark plug

The spark plug is an important engine component, which is easy to check. Since heat and deposits will cause any spark plug to slowly erode, the spark plug should be removed and checked in accordance with the periodic maintenance and lubrication chart. In addition, the condition of the spark plug can reveal the condition of the engine.

## To remove the spark plug

1. Remove panel A. (See page 6-6).
2. Remove the spark plug cap.

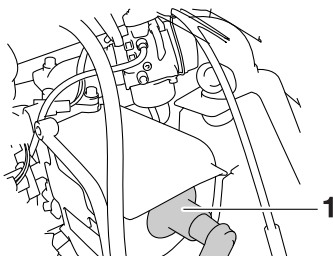

1. Spark plug cap

3. Remove the spark plug as shown, with a spark plug wrench available at a Yamaha dealer.

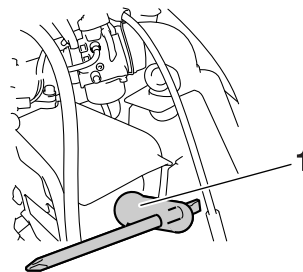

1. Spark plug wrench

## To check the spark plug

1. Check that the porcelain insulator around the center electrode of the spark plug is a medium-to-light tan (the ideal color when the vehicle is ridden normally).

## TIP

If the spark plug shows a distinctly different color, the engine could be operating improperly. Do not attempt to diagnose such problems yourself. Instead, have a Yamaha dealer check the vehicle.



# PERIODIC MAINTENANCE AND ADJUSTMENT

EAU20065

2. Check the spark plug for electrode erosion and excessive carbon or other deposits, and replace it if necessary.

## Specified spark plug:

YN50: NGK / BR8HS  
YN50M: NGK / BPR4HS

## To install the spark plug

1. Measure the spark plug gap with a wire thickness gauge and, if necessary, adjust the gap to specification.

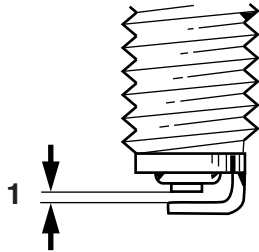

ZAJM0037

1. Spark plug gap

## Spark plug gap:

0.6–0.7 mm (0.024–0.028 in)

2. Clean the surface of the spark plug gasket and its mating surface, and then wipe off any grime from the spark plug threads.
3. Install the spark plug with the spark plug wrench, and then tighten it to the specified torque.

## Tightening torque:

Spark plug:  
20 Nm (2.0 m•kgf, 14.5 ft•lbf)

## TIP

If a torque wrench is not available when installing a spark plug, a good estimate of the correct torque is 1/4–1/2 turn past finger tight. However, the spark plug should be tightened to the specified torque as soon as possible.

4. Install the spark plug cap.
5. Install the panel.

## Final transmission oil

The final transmission case must be checked for oil leakage before each ride. If any leakage is found, have a Yamaha dealer check and repair the scooter. In addition, the final transmission oil must be changed as follows at the intervals specified in the periodic maintenance and lubrication chart.

1. Start the engine, warm up the final transmission oil by riding the scooter for several minutes, and then stop the engine.
2. Place the scooter on the centerstand.
3. Place an oil pan under the final transmission case to collect the used oil.
4. Remove the final transmission oil filler cap and its O-ring from the final transmission case.
5. Remove the final transmission oil drain bolt and its gasket to drain the oil from the final transmission case.

# PERIODIC MAINTENANCE AND ADJUSTMENT

EAU40371

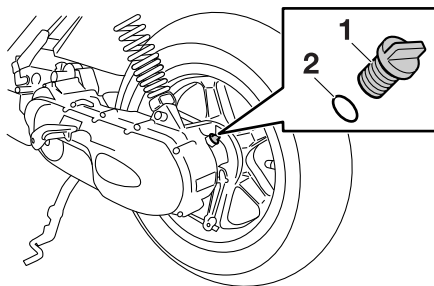

1. Final transmission oil filler cap
2. O-ring

6. Install the final transmission oil drain bolt and its new gasket, and then tighten the bolt to the specified torque.

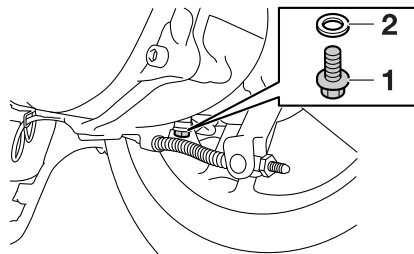

1. Final transmission oil drain bolt
2. Gasket

## Tightening torque:

Final transmission oil drain bolt:  
18 Nm (1.8 m•kgf, 13.0 ft•lbf)

7. Refill with the specified amount of the recommended final transmission oil. **WARNING! Make sure that no foreign material enters the final transmission case. Make sure that no oil gets on the tire or wheel.** [EWA11311]

## Recommended final transmission oil:

See page 8-1

## Oil quantity:

0.10 L (0.11 US qt, 0.09 Imp.qt)

8. Install the final transmission oil filler cap and its new O-ring, and then tighten the oil filler cap.
9. Check the final transmission case for oil leakage. If oil is leaking, check for the cause.

## Air filter element

The air filter element should be cleaned or replaced at the intervals specified in the periodic maintenance and lubrication chart. Have a Yamaha dealer clean or replace the air filter element.

# PERIODIC MAINTENANCE AND ADJUSTMENT

EAU21300

## Adjusting the carburetor

The carburetor is an important part of the engine and requires very sophisticated adjustment. Therefore, all carburetor adjustments should be left to a Yamaha dealer, who has the necessary professional knowledge and experience.

EAU21384

## Checking the throttle grip free play

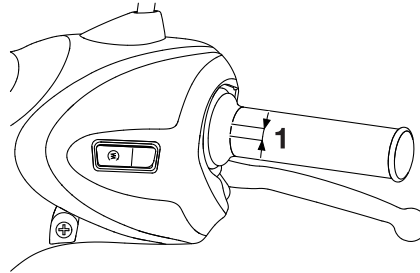

### 1. Throttle grip free play

The throttle grip free play should measure 4.0–6.0 mm (0.16–0.24 in) at the inner edge of the throttle grip. Periodically check the throttle grip free play and, if necessary, have a Yamaha dealer adjust it.

EAU33601

## Tires

To maximize the performance, durability, and safe operation of your vehicle, note the following points regarding the specified tires.

### Tire air pressure

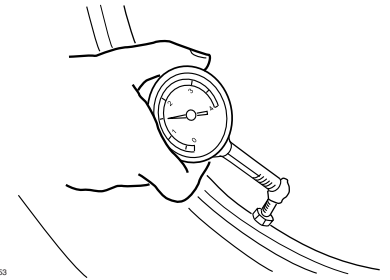

The tire air pressure should be checked and, if necessary, adjusted before each ride.

EWA10501

### **WARNING**

Operation of this vehicle with improper tire pressure may cause severe injury or death from loss of control.

- The tire air pressure must be checked and adjusted on cold

# PERIODIC MAINTENANCE AND ADJUSTMENT

tires (i.e., when the temperature of the tires equals the ambient temperature).

- The tire air pressure must be adjusted in accordance with the riding speed and with the total weight of rider, passenger, cargo, and accessories approved for this model.

## Tire air pressure (measured on cold tires):

### 0–90 kg (0–198 lb):

Front:

175 kPa (1.75 kgf/cm<sup>2</sup>,  
25 psi, 1.75 bar)

Rear:

200 kPa (2.00 kgf/cm<sup>2</sup>,  
29 psi, 2.00 bar)

### 90–163 kg (198–359 lb):

Front:

175 kPa (1.75 kgf/cm<sup>2</sup>,  
25 psi, 1.75 bar)

Rear:

225 kPa (2.25 kgf/cm<sup>2</sup>,  
33 psi, 2.25 bar)

### Maximum load\*:

163 kg (359 lb)

\* Total weight of rider, passenger, cargo and accessories

EWA10511

## **WARNING**

Never overload your vehicle. Operation of an overloaded vehicle could cause an accident.

## Tire inspection

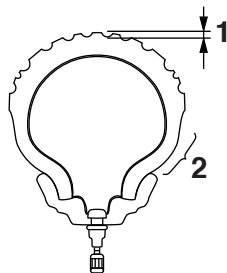

ZALUM0054

1. Tire tread depth
2. Tire sidewall

The tires must be checked before each ride. If the center tread depth reaches the specified limit, if the tire has a nail or glass fragments in it, or if the sidewall is cracked, have a Yamaha dealer replace the tire immediately.

## Minimum tire tread depth (front and rear):

1.6 mm (0.06 in)

## TIP

The tire tread depth limits may differ from country to country. Always comply with the local regulations.

## Tire information

This model is equipped with tubeless tires.

After extensive tests, only the tires listed below have been approved for this model by Yamaha Motor Co., Ltd.

**Front tire:**

Size:

120/70-12 M/C 51L

Manufacturer/model:

VEE RUBBER

CONTINENTAL / ZIPPY 1

PIRELLI / SL26

**Rear tire:**

Size:

130/70-12 M/C 56L

Manufacturer/model:

VEE RUBBER

CONTINENTAL / ZIPPY 1

PIRELLI / SL26

EWA10470

**WARNING**

- **Have a Yamaha dealer replace excessively worn tires. Besides being illegal, operating the vehicle with excessively worn tires decreases riding stability and can lead to loss of control.**
- **The replacement of all wheel and brake related parts, including the tires, should be left to a Yamaha dealer, who has the necessary professional knowledge and experience.**

## Cast wheels

To maximize the performance, durability, and safe operation of your vehicle, note the following points regarding the specified wheels.

- The wheel rims should be checked for cracks, bends, warpage or other damage before each ride. If any damage is found, have a Yamaha dealer replace the wheel. Do not attempt even the smallest repair to the wheel. A deformed or cracked wheel must be replaced.
- The wheel should be balanced whenever either the tire or wheel has been changed or replaced. An unbalanced wheel can result in poor performance, adverse handling characteristics, and a shortened tire life.

## Checking the front brake lever free play

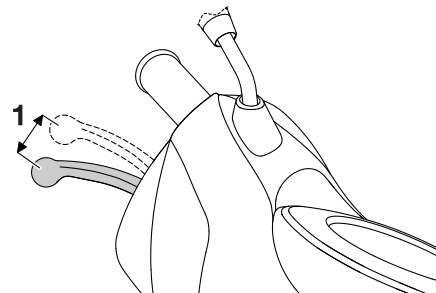

1. Front brake lever free play

The brake lever free play should measure 2.0 – 5.0 mm (0.08 – 0.20 in) as shown. Periodically check the brake lever free play and, if necessary, have a Yamaha dealer check the brake system.

EWA10641

**WARNING**

**An incorrect brake lever free play indicates a hazardous condition in the brake system. Do not operate the vehicle until the brake system has been checked or repaired by a Yamaha dealer.**

# PERIODIC MAINTENANCE AND ADJUSTMENT

EAU22170

## Adjusting the rear brake lever free play

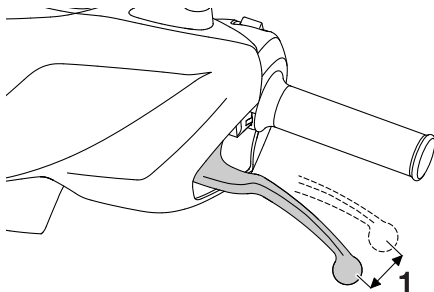

1. Rear brake lever free play

6

The brake lever free play should measure 5.0 – 10.0 mm (0.20 – 0.39 in) as shown. Periodically check the brake lever free play and, if necessary, adjust it as follows.

To increase the brake lever free play, turn the adjusting nut at the brake shoe plate in direction (a). To decrease the brake lever free play, turn the adjusting nut in direction (b).

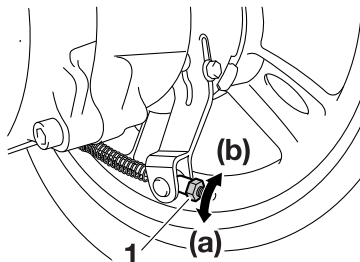

1. Adjusting nut

EWA10650



**WARNING**  
If proper adjustment cannot be obtained as described, have a Yamaha dealer make this adjustment.

EAU22380

## Checking the front brake pads and rear brake shoes

The front brake pads and the rear brake shoes must be checked for wear at the intervals specified in the periodic maintenance and lubrication chart.

EAU22400

### Front brake pads

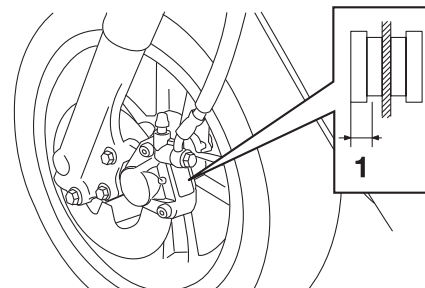

1. Lining thickness

Check each front brake pad for damage and measure the lining thickness. If a brake pad is damaged or if the lining thickness is less than 3.1 mm (0.12 in), have a Yamaha dealer replace the brake pads as a set.

# PERIODIC MAINTENANCE AND ADJUSTMENT

## Rear brake shoes

EAU43170

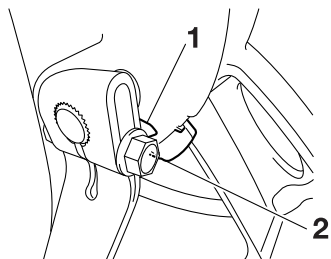

1. Wear indicator
2. Wear limit line

The rear brake is provided with a wear indicator, which allows you to check the brake shoe wear without having to disassemble the brake. To check the brake shoe wear, check the position of the wear indicator while applying the brake. If a brake shoe has worn to the point that the wear indicator reaches the wear limit mark, have a Yamaha dealer replace the brake shoes as a set.

## Checking the brake fluid level

EAU32344

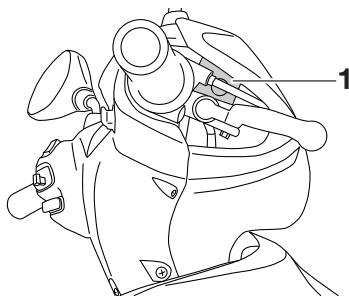

1. Front brake master cylinder

Insufficient brake fluid may allow air to enter the brake system, possibly causing it to become ineffective. Before riding, check that the brake fluid is above the minimum level mark and replenish if necessary. A low brake fluid level may indicate worn brake pads and/or brake system leakage. If the brake fluid level is low, be sure to check the brake pads for wear and the brake system for leakage.

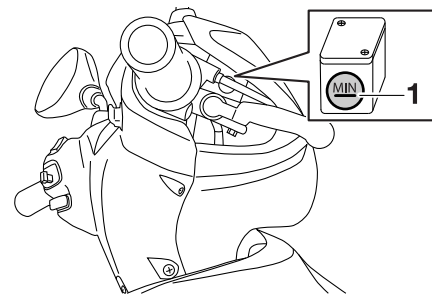

1. Minimum level mark

Observe these precautions:

- When checking the fluid level, make sure that the top of the master cylinder is level by turning the handlebars.
- Use only the recommended quality brake fluid, otherwise the rubber seals may deteriorate, causing leakage and poor braking performance.

**Recommended brake fluid:**  
DOT 4

- Refill with the same type of brake fluid. Mixing fluids may result in a harmful chemical reaction and lead to poor braking performance.

# PERIODIC MAINTENANCE AND ADJUSTMENT

---

- Be careful that water does not enter the master cylinder when refilling. Water will significantly lower the boiling point of the fluid and may result in vapor lock.
- Brake fluid may deteriorate painted surfaces or plastic parts. Always clean up spilled fluid immediately.
- As the brake pads wear, it is normal for the brake fluid level to gradually go down. However, if the brake fluid level goes down suddenly, have a Yamaha dealer check the cause.

EAUUM1360

## Changing the brake fluid

Have a Yamaha dealer change the brake fluid at the intervals specified in the periodic maintenance and lubrication chart. In addition, have the brake hose replaced every four years or whenever it is damaged or leaking.

EAU23094

## Checking and lubricating the cables

The operation of all control cables and the condition of the cables should be checked before each ride, and the cables and cable ends should be lubricated if necessary. If a cable is damaged or does not move smoothly, have a Yamaha dealer check or replace it. **WARNING! Damage to the outer housing of cables may result in internal rusting and cause interference with cable movement. Replace damaged cables as soon as possible to prevent unsafe conditions** [EWA10711]

### Recommended lubricant:

Yamaha Chain and Cable Lube or  
4-stroke engine oil



# PERIODIC MAINTENANCE AND ADJUSTMENT

EAU49920

## Checking and lubricating the throttle grip and cable

The operation of the throttle grip should be checked before each ride. In addition, the cable should be lubricated at the intervals specified in the periodic maintenance chart.

EAU23120

## Adjusting the Autolube pump

The operation of the throttle grip should be checked before each ride. In addition, the cable should be lubricated by a Yamaha dealer at the intervals specified in the periodic maintenance chart.

EAU43641

## Lubricating the front and rear brake levers

### Front brake lever

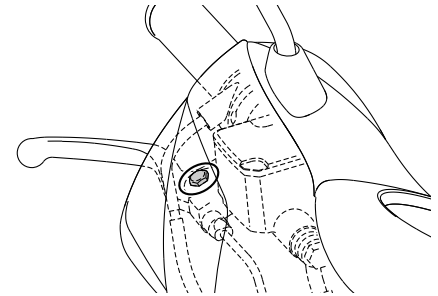

### Rear brake lever

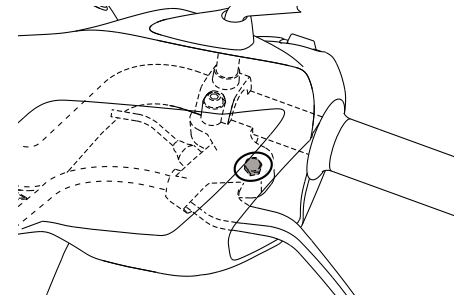

# PERIODIC MAINTENANCE AND ADJUSTMENT

The pivoting points of the front and rear brake levers must be lubricated at the intervals specified in the periodic maintenance and lubrication chart.

## Recommended lubricants:

Front brake lever:  
Silicone grease  
Rear brake lever:  
Lithium-soap-based grease

6

## Checking and lubricating the centerstand

EAU23192

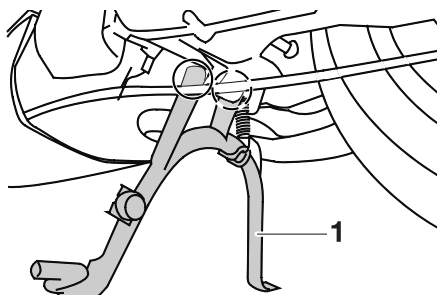

1. Centerstand

The operation of the centerstand should be checked before each ride, and the pivots and metal-to-metal contact surfaces should be lubricated if necessary.

EWA11301

## WARNING

If the centerstand does not move up and down smoothly, have a Yamaha dealer check or repair it. Otherwise, the centerstand could contact the ground and distract the operator, resulting in a possible loss of control.

Recommended lubricant:  
Lithium-soap-based grease

EAU23272

## Checking the front fork

The condition and operation of the front fork must be checked as follows at the intervals specified in the periodic maintenance and lubrication chart.

### To check the condition

Check the inner tubes for scratches, damage and excessive oil leakage.

### To check the operation

1. Place the vehicle on a level surface and hold it in an upright position. **WARNING! To avoid injury, securely support the vehicle so there is no danger of it falling over.** [EWA10751]
2. While applying the front brake, push down hard on the handlebars several times to check if the front fork compresses and rebounds smoothly.

# PERIODIC MAINTENANCE AND ADJUSTMENT

EAU45511

EAU23291

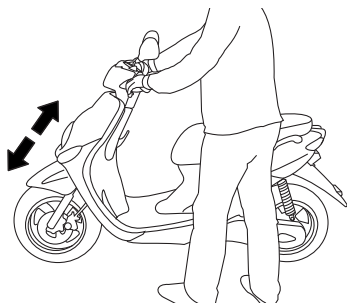

ECA10590

## NOTICE

If any damage is found or the front fork does not operate smoothly, have a Yamaha dealer check or repair it.

## Checking the steering

Worn or loose steering bearings may cause danger. Therefore, the operation of the steering must be checked as follows at the intervals specified in the periodic maintenance and lubrication chart.

1. Place the vehicle on the centerstand. **WARNING! To avoid injury, securely support the vehicle so there is no danger of it falling over.** [EWA10751]
2. Hold the lower ends of the front fork legs and try to move them forward and backward. If any free play can be felt, have a Yamaha dealer check or repair the steering.

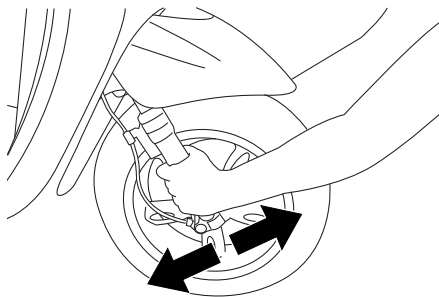

## Checking the wheel bearings



The front and rear wheel bearings must be checked at the intervals specified in the periodic maintenance and lubrication chart. If there is play in the wheel hub or if the wheel does not turn smoothly, have a Yamaha dealer check the wheel bearings.

# PERIODIC MAINTENANCE AND ADJUSTMENT

EAUM1403

## Battery

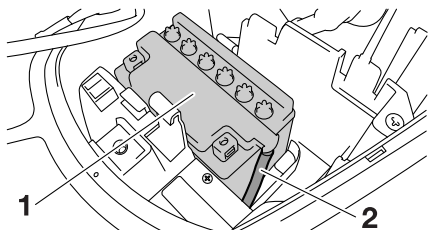

1. Battery
2. Battery breather hose

6

A poorly maintained battery will corrode and discharge quickly. The electrolyte level, battery lead connections and breather hose routing should be checked before each ride and at the intervals specified in the periodic maintenance and lubrication chart.

### To check the electrolyte level

1. Place the scooter on a level surface and hold it in an upright position.

### TIP

Make sure that the scooter is positioned straight up when checking the electrolyte level.

2. Remove panel A. (See page 6-6).
3. Check the electrolyte level in the battery.

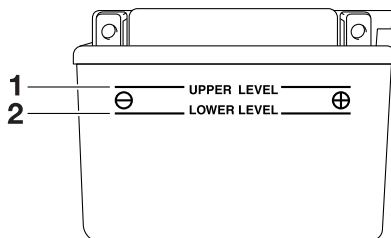

1. Maximum level mark
2. Minimum level mark

### TIP

The electrolyte should be between the minimum and maximum level marks.

4. If the electrolyte is at or below the minimum level mark, add distilled water to raise it to the maximum level mark. **NOTICE: Use only distilled water, as tap water**

contains minerals that are harmful to the battery. [ECA10611]

EWA10760

### WARNING

- **Electrolyte is poisonous and dangerous since it contains sulfuric acid, which causes severe burns. Avoid any contact with skin, eyes or clothing and always shield your eyes when working near batteries. In case of contact, administer the following FIRST AID.**
  - **EXTERNAL:** Flush with plenty of water.
  - **INTERNAL:** Drink large quantities of water or milk and immediately call a physician.
  - **EYES:** Flush with water for 15 minutes and seek prompt medical attention.

# PERIODIC MAINTENANCE AND ADJUSTMENT

EAU23503

- **Batteries produce explosive hydrogen gas. Therefore, keep sparks, flames, cigarettes, etc., away from the battery and provide sufficient ventilation when charging it in an enclosed space.**
- **KEEP THIS AND ALL BATTERIES OUT OF THE REACH OF CHILDREN.**

5. Check and, if necessary, tighten the battery lead connections and correct the breather hose routing.

## To store the battery

1. If the scooter will not be used for more than one month, remove the battery, fully charge it, and then place it in a cool, dry place.  
**NOTICE: When removing the battery, be sure the key is turned to “⊗”, then disconnect the negative lead before disconnecting the positive lead.**  
[ECA16302]
2. If the battery will be stored for more than two months, check the specific gravity of the electrolyte

at least once a month and fully charge the battery whenever necessary.

3. Fully charge the battery before installation.
4. After installation, make sure that the battery leads are properly connected to the battery terminals and that the breather hose is properly routed, in good condition, and not obstructed. **NOTICE: If the breather hose is positioned in such a way that the frame is exposed to electrolyte or gas expelled from the battery, the frame could suffer structural and external damages.** [ECA10601]

## Replacing the fuse

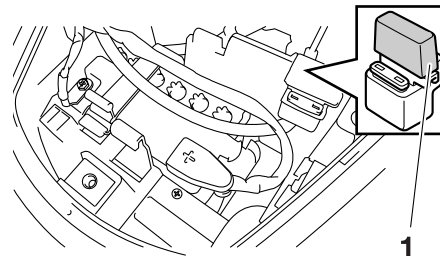

1. Main fuse

The fuse holder is located behind panel A. (See page 6-6).  
If the fuse is blown, replace it as follows.

1. Turn the key to “⊗” and turn off all electrical circuits.
2. Remove the blown fuse, and then install a new fuse of the specified amperage. **WARNING! Do not use a fuse of a higher amperage rating than recommended to avoid causing extensive damage to the electrical system and possibly a fire.** [EWA15131]

# PERIODIC MAINTENANCE AND ADJUSTMENT

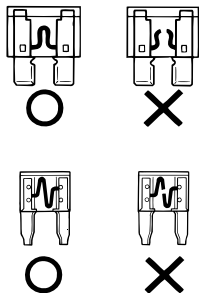

**Specified fuse:**  
7.5 A

3. Turn the key to “○” and turn on the electrical circuits to check if the devices operate.
4. If the fuse immediately blows again, have a Yamaha dealer check the electrical system.

EAUS1402

## Replacing the headlight bulb

If the headlight bulb burns out, replace it as follows.

ECA10650

### **NOTICE**

Take care not to damage the following parts:

- **Headlight bulb**

Do not touch the glass part of the headlight bulb to keep it free from oil, otherwise the transparency of the glass, the luminosity of the bulb, and the bulb life will be adversely affected. Thoroughly clean off any dirt and fingerprints on the headlight bulb using a cloth moistened with alcohol or thinner.

- **Headlight lens**

Do not affix any type of tinted film or stickers to the headlight lens.

Do not use a headlight bulb of a wattage higher than specified.

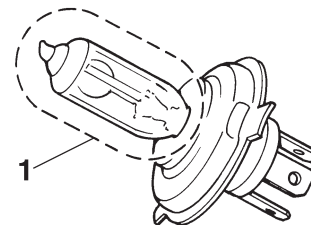

1. Do not touch the glass part of the bulb

ECA10670

### **NOTICE**

It is advisable to have a Yamaha dealer perform this job.

1. Place the scooter on the centerstand.
2. Remove cowling A. (See page 6-6).
3. Disconnect the headlight coupler.

# PERIODIC MAINTENANCE AND ADJUSTMENT

EAUT1262

## Replacing a front turn signal light bulb

ECA10670

### NOTICE

It is advisable to have a Yamaha dealer perform this job.

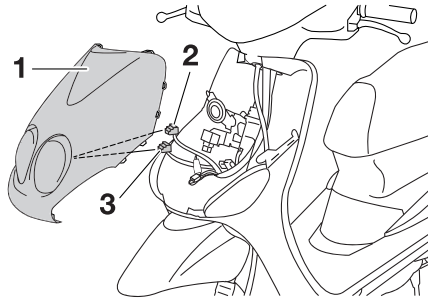

1. Cowling
2. Headlight coupler
3. Auxiliary light lead connector

4. Remove the headlight bulb cover.

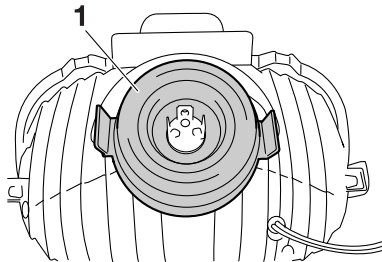

1. Headlight bulb cover

5. Unhook the headlight bulb holder, and then remove the burnt-out bulb.

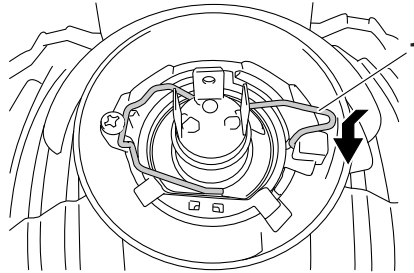

1. Headlight bulb holder

6. Place a new headlight bulb into position, and then secure it with the bulb holder.
7. Install the headlight bulb cover.
8. Connect the headlight coupler.
9. Install the cowling.
10. Have a Yamaha dealer adjust the headlight beam if necessary.

1. Place the scooter on the centers-stand.
2. Remove cowling A. (See page 6-6).
3. Remove the socket (together with the bulb) by turning it counterclockwise.

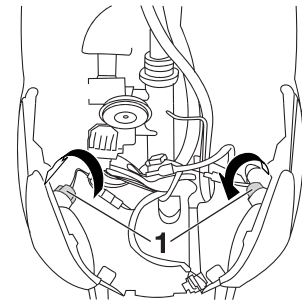

1. Turn signal light bulb socket

4. Remove the burnt-out bulb by pushing it in and turning it counterclockwise.

# PERIODIC MAINTENANCE AND ADJUSTMENT

5. Insert a new bulb into the socket, push it in, and then turn it clockwise until it stops.
6. Install the socket (together with the bulb) by turning it clockwise.
7. Install the cowling.

EAU24283

## Replacing a turn signal light bulb or the tail/brake light bulb

1. Remove the lens by removing the screws.

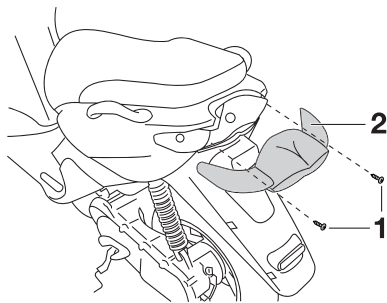

1. Screw
2. Tail/brake light lens / Turn signal light lens

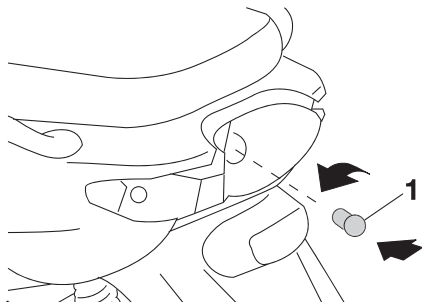

1. Tail/brake light bulb



1. Turn signal light bulb
2. Remove the burnt-out bulb by pushing it in and turning it counterclockwise.
3. Insert a new bulb into the socket, push it in, and then turn it clockwise until it stops.
4. Install the lens by installing the screws. **NOTICE: Do not over-tighten the screws, otherwise the lens may break.** [ECA10681]



# PERIODIC MAINTENANCE AND ADJUSTMENT

EAUS1151

## Replacing the license plate light bulb (Depends on models)

1. Remove the lens by removing the screw.

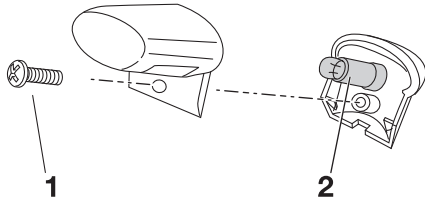

1. Screw
2. License plate light bulb socket

2. Remove the burnt out bulb by pulling it out.
3. Insert a new bulb into the socket.
4. Install the lens by installing the screw. **NOTICE: Do not over-tighten the screw, otherwise the lens may break.** [ECA11191]

EAU45462

## Replacing the auxiliary light bulb (Depends on models)

If the auxiliary light bulb burns out, replace it as follows.

1. Place the vehicle on the centers-stand.
2. Remove cowling A. (See page 6-6).
3. Remove the auxiliary light socket (together with the bulb) by pulling it out.

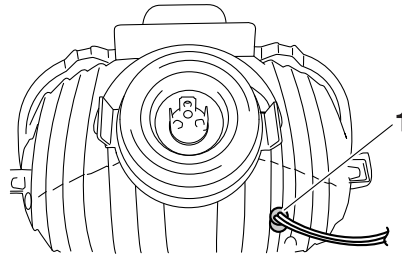

1. Auxiliary light bulb socket

4. Remove the burnt-out bulb by pulling it out.

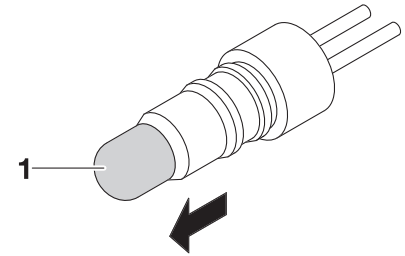

1. Auxiliary light bulb

5. Insert a new bulb into the socket.
6. Install the auxiliary light socket (together with the bulb) by pushing it in.
7. Install the cowling.

# PERIODIC MAINTENANCE AND ADJUSTMENT

---

EAU25861

EWA15141

## Troubleshooting

Although Yamaha scooters receive a thorough inspection before shipment from the factory, trouble may occur during operation. Any problem in the fuel, compression, or ignition systems, for example, can cause poor starting and loss of power.

The following troubleshooting chart represents a quick and easy procedure for checking these vital systems yourself. However, should your scooter require any repair, take it to a Yamaha dealer, whose skilled technicians have the necessary tools, experience, and know-how to service the scooter properly.

Use only genuine Yamaha replacement parts. Imitation parts may look like Yamaha parts, but they are often inferior, have a shorter service life and can lead to expensive repair bills.

### **WARNING**

**When checking the fuel system, do not smoke, and make sure there are no open flames or sparks in the area, including pilot lights from water heaters or furnaces. Gasoline or gasoline vapors can ignite or explode, causing severe injury or property damage.**

---

## Troubleshooting chart

### 1. Fuel

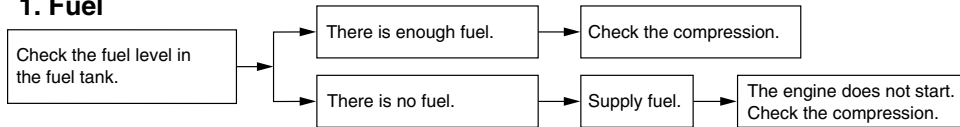

### 2. Compression

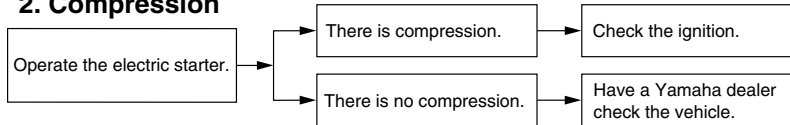

### 3. Ignition

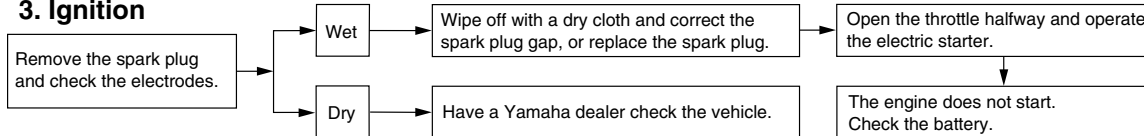

### 4. Battery

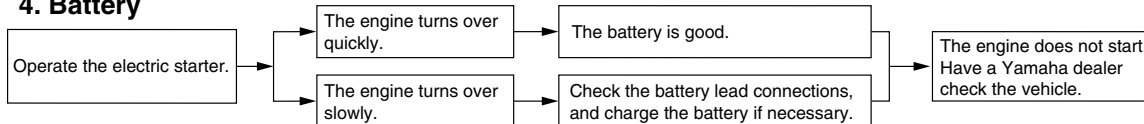

# SCOOTER CARE AND STORAGE

---

EAU37833

## Matte color caution

ECA15192

### **NOTICE**

Some models are equipped with matte colored finished parts. Be sure to consult a Yamaha dealer for advice on what products to use before cleaning the vehicle.

Using a brush, harsh chemical products or cleaning compounds when cleaning these parts will scratch or damage their surface. Wax also should not be applied to any matte colored finished parts.

---

EAU26094

## Care

While the open design of a scooter reveals the attractiveness of the technology, it also makes it more vulnerable. Rust and corrosion can develop even if high-quality components are used. A rusty exhaust pipe may go unnoticed on a car, however, it detracts from the overall appearance of a scooter. Frequent and proper care does not only comply with the terms of the warranty, but it will also keep your scooter looking good, extend its life and optimize its performance.

### Before cleaning

1. Cover the muffler outlet with a plastic bag after the engine has cooled down.
2. Make sure that all caps and covers as well as all electrical couplers and connectors, including the spark plug cap, are tightly installed.
3. Remove extremely stubborn dirt, like oil burnt onto the crankcase, with a degreasing agent and a

brush, but never apply such products onto seals, gaskets and wheel axles. Always rinse the dirt and degreaser off with water.

### Cleaning

ECA10783

### **NOTICE**

- Avoid using strong acidic wheel cleaners, especially on spoked wheels. If such products are used on hard-to-remove dirt, do not leave the cleaner on the affected area any longer than instructed. Also, thoroughly rinse the area off with water, immediately dry it, and then apply a corrosion protection spray.
- Improper cleaning can damage plastic parts (such as cowlings, panels, windshields, headlight lenses, meter lenses, etc.) and the mufflers. Use only a soft, clean cloth or sponge with water to clean plastic. However, if the plastic parts cannot be thoroughly cleaned with water, diluted mild detergent

# SCOOTER CARE AND STORAGE

with water may be used. Be sure to rinse off any detergent residue using plenty of water, as it is harmful to plastic parts.

- Do not use any harsh chemical products on plastic parts. Be sure to avoid using cloths or sponges which have been in contact with strong or abrasive cleaning products, solvent or thinner, fuel (gasoline), rust removers or inhibitors, brake fluid, antifreeze or electrolyte.
- Do not use high-pressure washers or steam-jet cleaners since they cause water seepage and deterioration in the following areas: seals (of wheel and swingarm bearings, fork and brakes), electric components (couplers, connectors, instruments, switches and lights), breather hoses and vents.
- For scooters equipped with a windshield: Do not use strong cleaners or hard sponges as they will cause dulling or scratching. Some cleaning compounds for plastic may leave

scratches on the windshield. Test the product on a small hidden part of the windshield to make sure that it does not leave any marks. If the windshield is scratched, use a quality plastic polishing compound after washing.

## After normal use

Remove dirt with warm water, a mild detergent, and a soft, clean sponge, and then rinse thoroughly with clean water. Use a toothbrush or bottle-brush for hard-to-reach areas. Stubborn dirt and insects will come off more easily if the area is covered with a wet cloth for a few minutes before cleaning.

## After riding in the rain, near the sea or on salt-sprayed roads

Since sea salt or salt sprayed on the roads during winter are extremely corrosive in combination with water, carry out the following steps after each ride in the rain, near the sea or on salt-sprayed roads.

## TIP

Salt sprayed on roads in the winter may remain well into spring.

1. Clean the scooter with cold water and a mild detergent after the engine has cooled down. **NOTICE: Do not use warm water since it increases the corrosive action of the salt.** [ECA10791]
2. Apply a corrosion protection spray on all metal, including chrome- and nickel-plated, surfaces to prevent corrosion.

## After cleaning

1. Dry the scooter with a chamois or an absorbing cloth.
2. Use a chrome polish to shine chrome, aluminum and stainless-steel parts, including the exhaust system. (Even the thermally induced discoloring of stainless-steel exhaust systems can be removed through polishing.)

# SCOOTER CARE AND STORAGE

---

3. To prevent corrosion, it is recommended to apply a corrosion protection spray on all metal, including chrome- and nickel-plated, surfaces.
4. Use spray oil as a universal cleaner to remove any remaining dirt.
5. Touch up minor paint damage caused by stones, etc.
6. Wax all painted surfaces.
7. Let the scooter dry completely before storing or covering it.

EWA10942

## WARNING

Contaminants on the brakes or tires can cause loss of control.

- **Make sure that there is no oil or wax on the brakes or tires. If necessary, clean the brake discs and brake linings with a regular brake disc cleaner or acetone, and wash the tires with warm water and a mild detergent.**
  - **Before operating the scooter test its braking performance and cornering behavior.**
- 

ECA10800

## NOTICE

- **Apply spray oil and wax sparingly and make sure to wipe off any excess.**
  - **Never apply oil or wax to any rubber and plastic parts, but treat them with a suitable care product.**
  - **Avoid using abrasive polishing compounds as they will wear away the paint.**
- 

## TIP

- Consult a Yamaha dealer for advice on what products to use.
  - Washing, rainy weather or humid climates can cause the headlight lens to fog. Turning the headlight on for a short period of time will help remove the moisture from the lens.
- 

EAU26303

## Storage

### Short-term

Always store your scooter in a cool, dry place and, if necessary, protect it against dust with a porous cover. Be sure the engine and the exhaust system are cool before covering the scooter.

ECA10820

## NOTICE

- **Storing the scooter in a poorly ventilated room or covering it with a tarp, while it is still wet, will allow water and humidity to seep in and cause rust.**
  - **To prevent corrosion, avoid damp cellars, stables (because of the presence of ammonia) and areas where strong chemicals are stored.**
- 

### Long-term

Before storing your scooter for several months:

1. Follow all the instructions in the “Care” section of this chapter.

# SCOOTER CARE AND STORAGE

2. Drain the carburetor float chamber by loosening the drain bolt; this will prevent fuel deposits from building up. Pour the drained fuel into the fuel tank.
3. Fill up the fuel tank and add fuel stabilizer (if available) to prevent the fuel tank from rusting and the fuel from deteriorating.
4. Perform the following steps to protect the cylinder, piston rings, etc. from corrosion.
  - a. Remove the spark plug cap and spark plug.
  - b. Pour a teaspoonful of engine oil into the spark plug bore.
  - c. Install the spark plug cap onto the spark plug, and then place the spark plug on the cylinder head so that the electrodes are grounded. (This will limit sparking during the next step.)
  - d. Turn the engine over several times with the starter. (This will coat the cylinder wall with oil.) **WARNING! To prevent damage or injury from sparking, make sure to ground**

**the spark plug electrodes while turning the engine over.** [EWA10951]

- e. Remove the spark plug cap from the spark plug, and then install the spark plug and the spark plug cap.
5. Lubricate all control cables and the pivoting points of all levers and pedals as well as of the sidestand/centerstand.
6. Check and, if necessary, correct the tire air pressure, and then lift the scooter so that both of its wheels are off the ground. Alternatively, turn the wheels a little every month in order to prevent the tires from becoming degraded in one spot.
7. Cover the muffler outlet with a plastic bag to prevent moisture from entering it.
8. Remove the battery and fully charge it. Store it in a cool, dry place and charge it once a month. Do not store the battery in an excessively cold or warm place [less than 0 °C (30 °F) or more than 30 °C (90 °F)]. For more

information on storing the battery, see page 6-19.

## TIP

Make any necessary repairs before storing the scooter.

# SPECIFICATIONS

## Dimensions:

Overall length:  
1840 mm (72.4 in)  
Overall width:  
793 mm (31.2 in)  
Overall height:  
1260 mm (49.6 in)  
Seat height:  
793 mm (31.2 in)  
Wheelbase:  
1275 mm (50.2 in)  
Ground clearance:  
146 mm (5.75 in)  
Minimum turning radius:  
3880 mm (152.8 in)

## Weight:

Curb weight:  
88.0 kg (194 lb)

## Engine:

Engine type:  
Air cooled 2-stroke  
Cylinder arrangement:  
Forward-inclined single cylinder  
Displacement:  
49 cm<sup>3</sup>  
Bore x stroke:  
40.0 x 39.2 mm (1.57 x 1.54 in)  
Compression ratio:  
YN50: 11.00 :1  
YN50M: 10.00 :1  
Starting system:  
Electric starter and kickstarter

Lubrication system:  
Separate lubrication (Yamaha autolube)

Type:  
YAMALUBE 2 or 2-stroke engine oil

## Engine oil quantity:

Quantity:  
1.50 L (1.59 US qt, 1.32 Imp.qt)

## Transmission oil:

Type:  
YAMALUBE 4 (10W-40) or SAE 10W-40  
Oil change quantity:  
0.10 L (0.11 US qt, 0.09 Imp.qt)

## Air filter:

Air filter element:  
Wet element

## Fuel:

Recommended fuel:  
Regular unleaded gasoline only  
Fuel tank capacity:  
6.1 L (1.61 US gal, 1.34 Imp.gal)  
Fuel reserve amount:  
1.4 L (0.37 US gal, 0.31 Imp.gal)

## Carburetor:

Manufacturer:  
GURTNER  
Type x quantity:  
PY12 x 1

## Spark plug (s):

Manufacturer/model:  
YN50: NGK/BR8HS  
YN50M: NGK/BPR4HS  
Spark plug gap:  
0.6–0.7 mm (0.024–0.028 in)

Clutch type:  
Dry, centrifugal automatic

## Transmission:

Primary reduction ratio:  
1  
Secondary reduction system:  
Gear  
Secondary reduction ratio:  
YN50: 12.923 (52/13 x 42/13)  
YN50M: 15.000 (52/12 x 45/13)  
Transmission type:  
V-belt automatic

## Chassis:

Frame type:  
Underbone  
Caster angle:  
26.50 °  
Trail:  
92.6 mm (3.65 in)

## Front tire:

Type:  
Tubeless  
Size:  
120/70-12 M/C 51L  
Manufacturer/model:  
VEE RUBBER  
Manufacturer/model:  
CONTINENTAL / ZIPPY 1  
Manufacturer/model:  
PIRELLI / SL26

## Rear tire:

Type:  
Tubeless



Size:  
130/70-12 M/C 56L  
Manufacturer/model:  
VEE RUBBER  
Manufacturer/model:  
CONTINENTAL / ZIPPY 1  
Manufacturer/model:  
PIRELLI / SL26

## Loading:

Maximum load:  
163 kg (359 lb)  
(Total weight of rider, passenger, cargo  
and accessories)

## Tire air pressure (measured on cold tires):

Loading condition:  
0–90 kg (0–198 lb)  
Front:  
175 kPa (1.75 kgf/cm<sup>2</sup>, 25 psi, 1.75 bar)  
Rear:  
200 kPa (2.00 kgf/cm<sup>2</sup>, 29 psi, 2.00 bar)  
Loading condition:  
90–163 kg (198–359 lb)  
Front:  
175 kPa (1.75 kgf/cm<sup>2</sup>, 25 psi, 1.75 bar)  
Rear:  
225 kPa (2.25 kgf/cm<sup>2</sup>, 33 psi, 2.25 bar)

## Front wheel:

Wheel type:  
Cast wheel  
Rim size:  
12 M/C xMT3.50

## Rear wheel:

Wheel type:  
Cast wheel

Rim size:  
12 M/C xMT3.50

## Front brake:

Type:  
Single disc brake  
Operation:  
Right hand operation  
Recommended fluid:  
DOT 4

## Rear brake:

Type:  
Drum brake  
Operation:  
Left hand operation

## Front suspension:

Type:  
Telescopic fork  
Spring/shock absorber type:  
Coil spring/oil damper  
Wheel travel:  
70.0 mm (2.76 in)

## Rear suspension:

Type:  
Unit swing  
Spring/shock absorber type:  
Coil spring/oil damper  
Wheel travel:  
60.0 mm (2.36 in)

## Electrical system:

Ignition system:  
CDI  
Charging system:  
AC magneto

## Battery:

Model:  
YB 4L-B  
Voltage, capacity:  
12 V, 4.0 Ah

## Headlight:

Bulb type:  
Halogen bulb

## Bulb voltage, wattage x quantity:

Headlight:  
12 V, 35 W/35 W x 1  
Tail/brake light:  
12 V, 21.0 W/5.0 W x 1  
Front turn signal light:  
12 V, 10.0 W x 2  
Rear turn signal light:  
12 V, 10.0 W x 2  
License plate light:  
12 V, 5.0 W x 1  
Meter lighting:  
LED  
High beam indicator light:  
LED  
Oil level warning light:  
LED  
Turn signal indicator light:  
LED  
Fuel level warning light:  
LED

## Fuses:

Main Fuse:  
7.5 A

# CONSUMER INFORMATION

EAU48611

## Identification numbers

Record the vehicle identification number and model label information in the spaces provided below for assistance when ordering spare parts from a Yamaha dealer or for reference in case the vehicle is stolen.

VEHICLE IDENTIFICATION NUMBER:

MODEL LABEL INFORMATION:

EAU26410

## Vehicle identification number

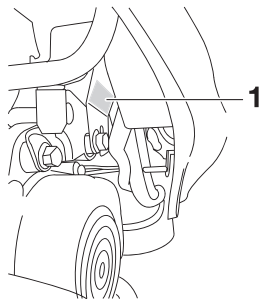

1. Vehicle identification number

The vehicle identification number is stamped into the frame.

### TIP

The vehicle identification number is used to identify your vehicle and may be used to register it with the licensing authority in your area.

EAU26490

## Model label

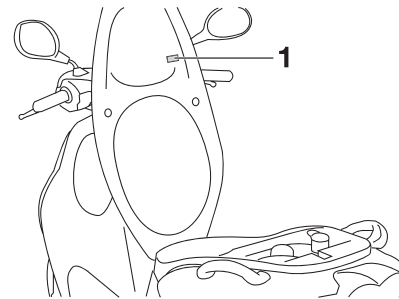

1. Model label

The model label is affixed to the bottom of the seat. (See page 3-10). Record the information on this label in the space provided. This information will be needed when ordering spare parts from a Yamaha dealer.

- 2-stroke engine oil .....3-10
- A**
- Acceleration and deceleration .....5-2
  - Air filter element.....6-9
  - Autolube pump, adjusting.....6-16
  - Auxiliary light bulb, replacing.....6-24
- B**
- Battery.....6-19
  - Brake fluid level, checking.....6-14
  - Brake fluid, changing.....6-15
  - Brake lever, front.....3-6
  - Brake lever, rear.....3-6
  - Brake levers, lubricating .....6-16
  - Brake pads and shoes, checking .....6-13
  - Braking.....5-2
- C**
- Cables, checking and lubricating .....6-15
  - Carburetor,adjusting.....6-10
  - Care.....7-1
  - Catalytic converter.....3-9
  - Centerstand, checking and lubricating....6-17
  - Cowling and panel, removing and installing.....6-6
- D**
- Dimmer switch .....3-6
- E**
- Engine break-in.....5-3
- F**
- Final transmission oil .....6-8
  - Front brake lever free play, checking.....6-12
  - Front fork, checking.....6-17
  - Fuel .....3-8
  - Fuel and 2-stroke engine oil tank caps .....3-7
  - Fuel consumption, tips for reducing.....5-3
  - Fuel level warning light .....3-2
  - Fuel tank breather/overflow hose .....3-9
  - Fuse, replacing.....6-20
- H**
- Handlebar switches .....3-5
  - Headlight bulb, replacing.....6-21
  - High beam indicator light.....3-2
  - Horn switch.....3-6
- I**
- Identification numbers .....9-1
  - Indicator and warning lights .....3-2
- K**
- Kickstarter.....3-10
- L**
- License plate light bulb, replacing.....6-24
  - Luggage hook.....3-12
- M**
- Main switch/steering lock.....3-1
  - Maintenance and lubrication, periodic .....6-3
  - Maintenance, emission control system .....6-2
  - Matte color, caution.....7-1
  - Model label .....9-1
  - Multi-function display .....3-3
- O**
- Oil level warning light.....3-2
- P**
- Parking.....5-4
  - Part locations.....2-1
- R**
- Rear brake lever free play, adjusting .....6-13
- S**
- Safe-riding points.....1-5
  - Safety information.....1-1
  - Seat.....3-10
  - Spark plug, checking .....6-7
  - Specifications.....8-1
  - Start switch.....3-6
  - Starting a cold engine.....5-1
  - Starting off .....5-1
  - Steering, checking .....6-18
  - Storage.....7-3
  - Storage compartment.....3-11
- T**
- Throttle grip and cable, checking and lubricating .....6-16
  - Throttle grip free play, checking .....6-10
  - Tires .....6-10
  - Troubleshooting .....6-25
  - Troubleshooting chart .....6-26
  - Turn signal indicator light.....3-2
  - Turn signal light bulb (front), replacing ....6-22
  - Turn signal light bulb or tail/brake light bulb, replacing .....6-23
  - Turn signal switch .....3-6
- V**
- Vehicle identification number.....9-1
- W**
- Wheel bearings, checking.....6-18
  - Wheels .....6-12











PRINTED IN SPAIN  
2010.09  
(E)