

The following is a general guide for installing a big bore kit or rebuilding the GY6 type engine. It is not complete and I hope to improve on it over time. I encourage anyone who has photos or suggestions for improving this guide to email Lee@ScootDawg.com The photographs in this booklet are installing an 80cc bore kit in a 50cc GY6. Readers should take note that there can be minor variations in this as there are numerous companies in China who manufacture the GY6.

The first step in the install is to take an inventory of the parts you have received in the kit. Depending on who you buy from, you may or may not have a new camshaft. Then you need to read, research and feel comfortable that you have a basic understanding of every step before you even touch a wrench.

Some of the photographs used show the engine removed from the scooter. It is not necessary to remove the engine from the scooter. As a matter of fact the scooter provides a solid place to hold the engine while you work. It is very helpful to get the scooter elevated so the engine is at a good working level. Remove all the body panels from around the engine. Keep your work area clean and lay out parts in an orderly manner as you remove them. Take pictures and notes. It's easy to forget how things go back together.



Fig 1. Body panels removed for full access to engine

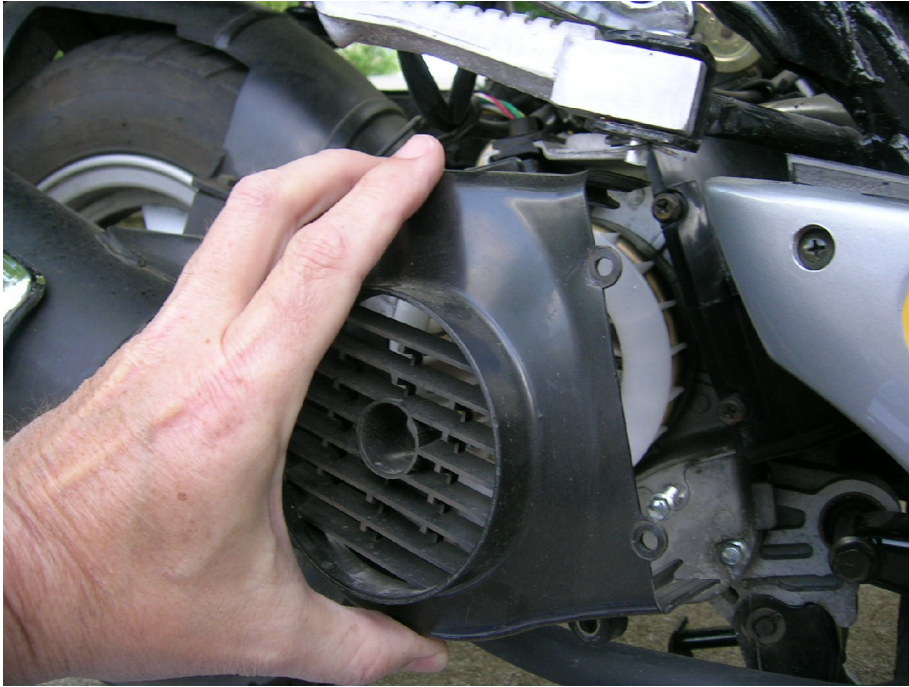

Fig. 2. Remove fan cover



Fig. 3. Remove carb inlet tube.

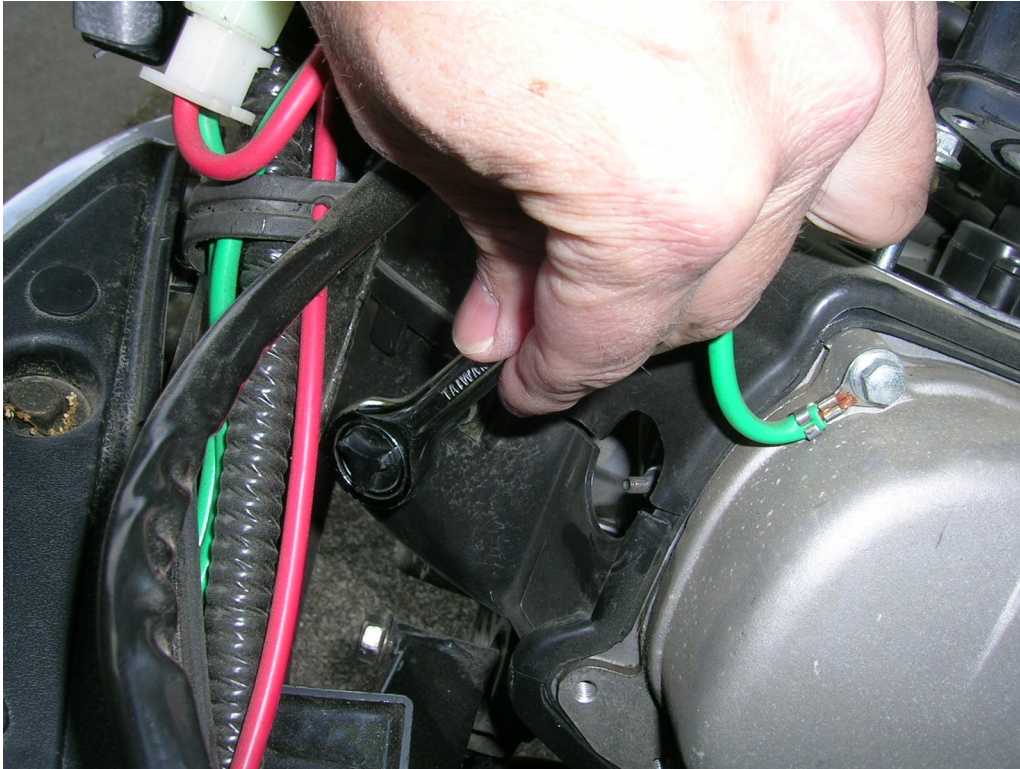

Fig. 4. Remove plastic cover around engine

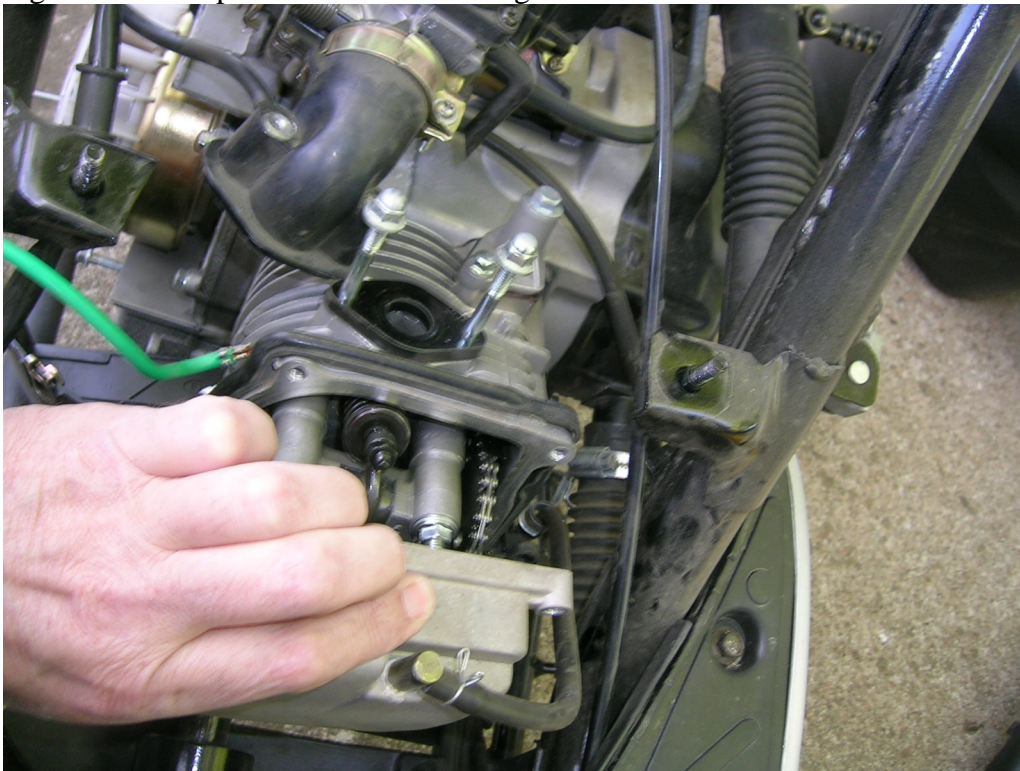

Fig. 5. Remove cylinder head cover.

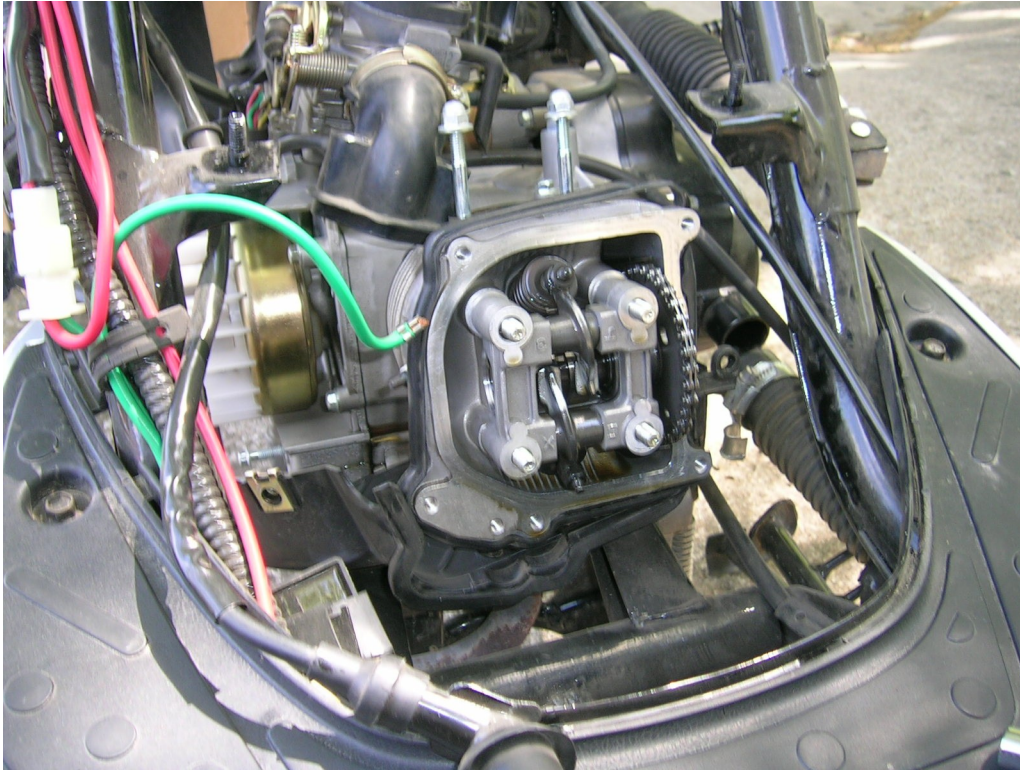

Fig. 6. Remove camshaft caps (before)

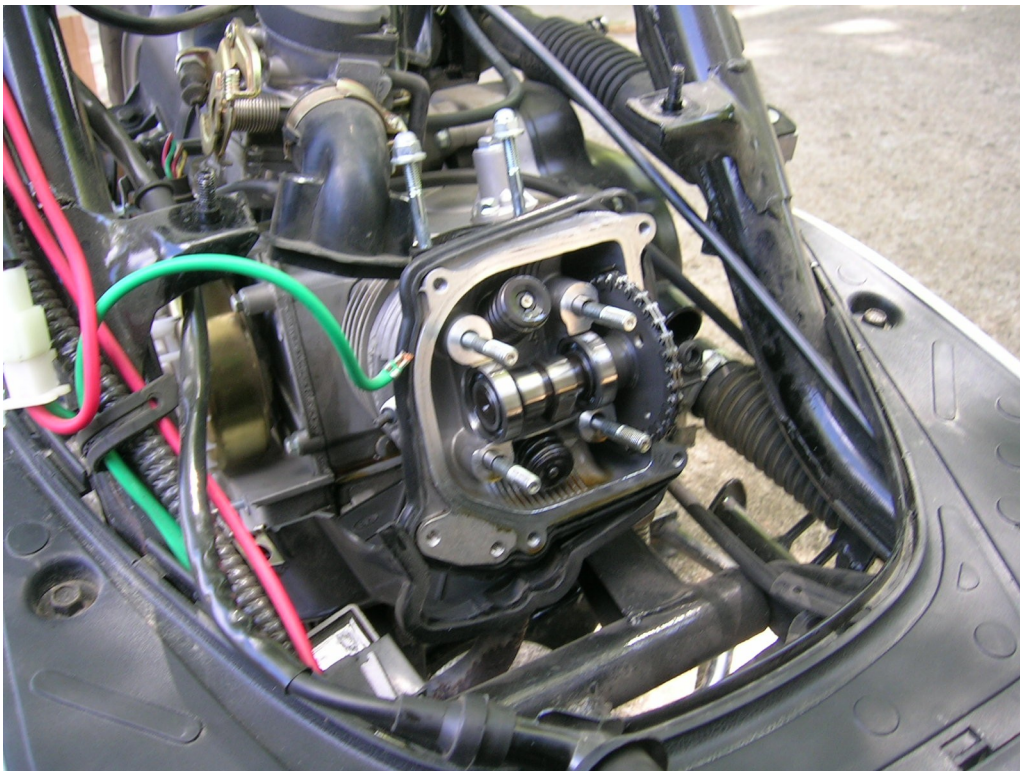
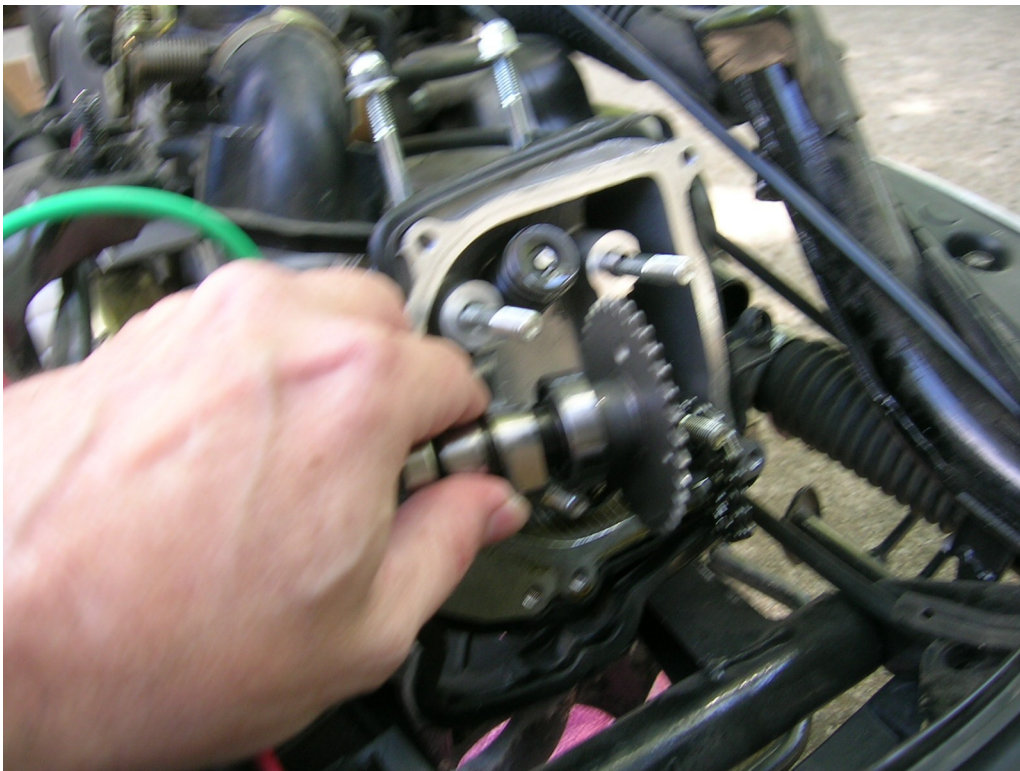

Fig. 7. After



Fig. 8. Remove the chain regulator



Figs. 9 a & b. Remove the camshaft.

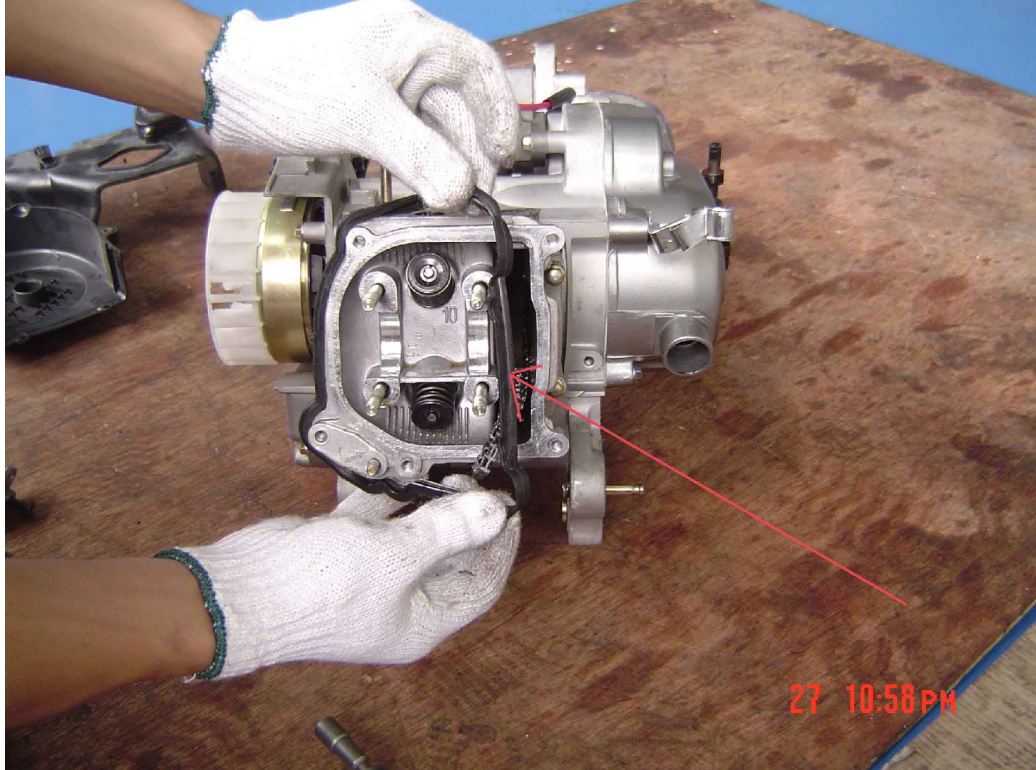
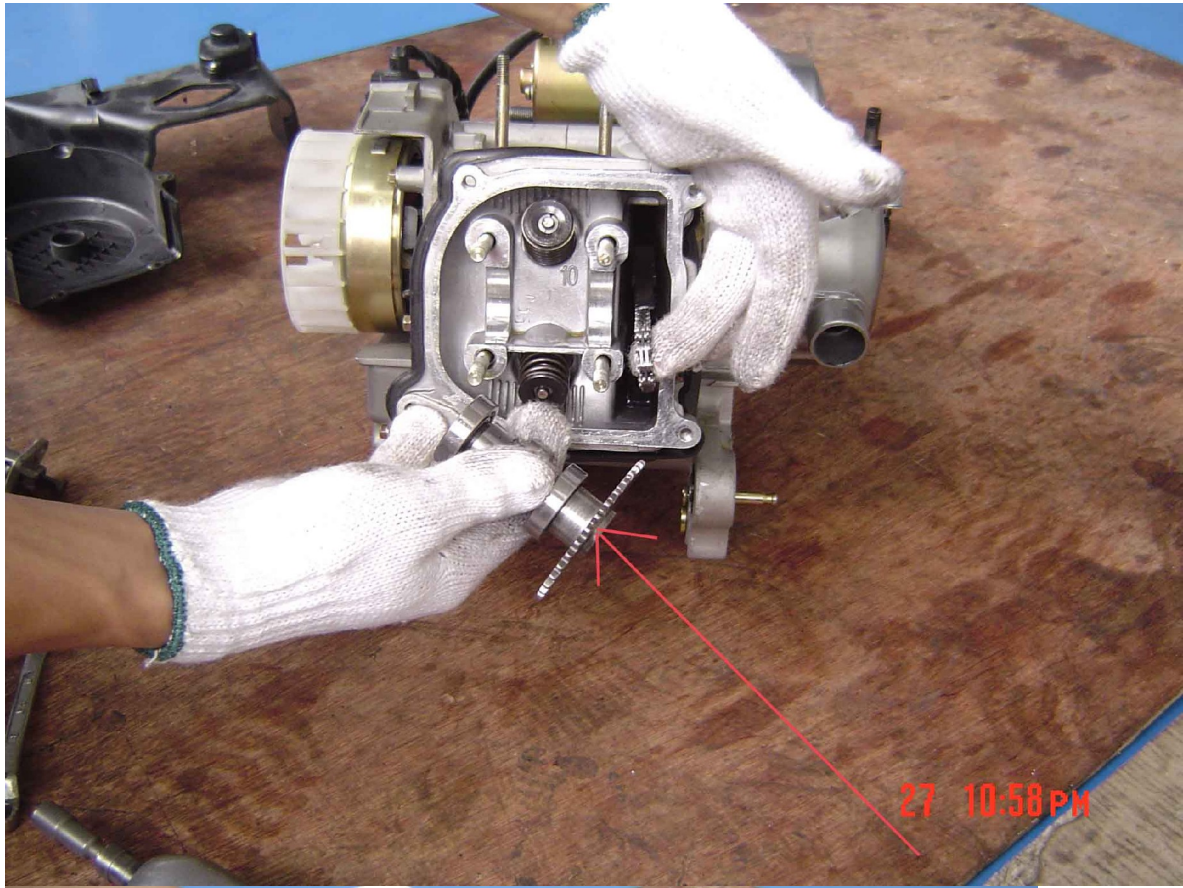

Fig. 10. Remove Gasket.

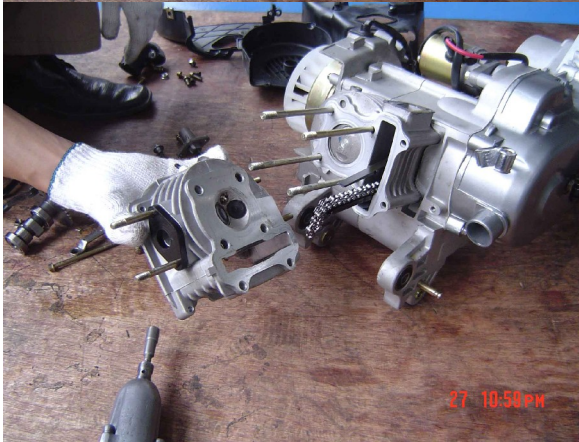

Fig. 11. Remove cylinder head.

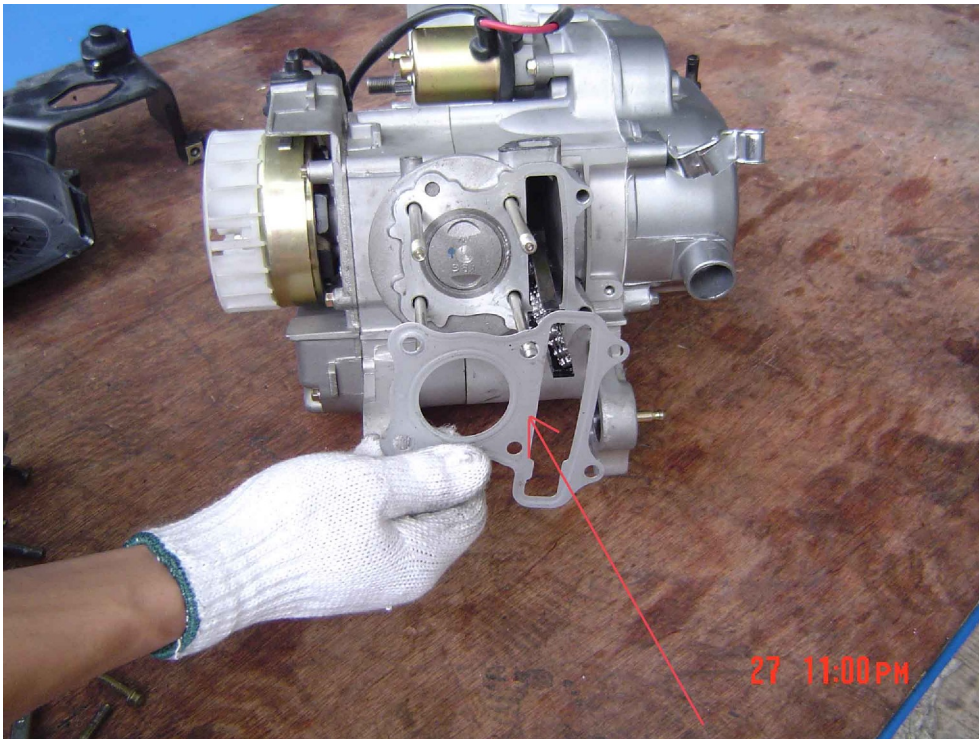

Fig. 12. Remove gasket



Fig. 13. Remove chain guide.

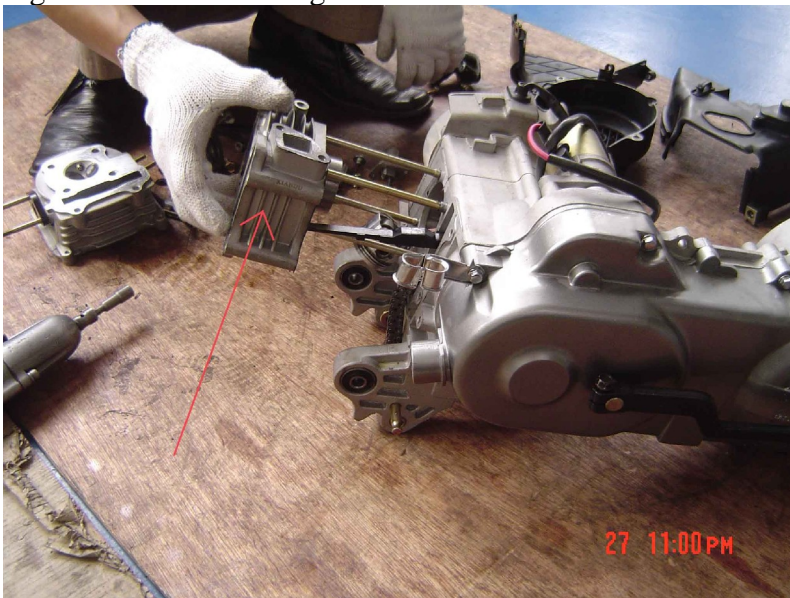

Fig. 14. Remove cylinder. This is starting to get fun!

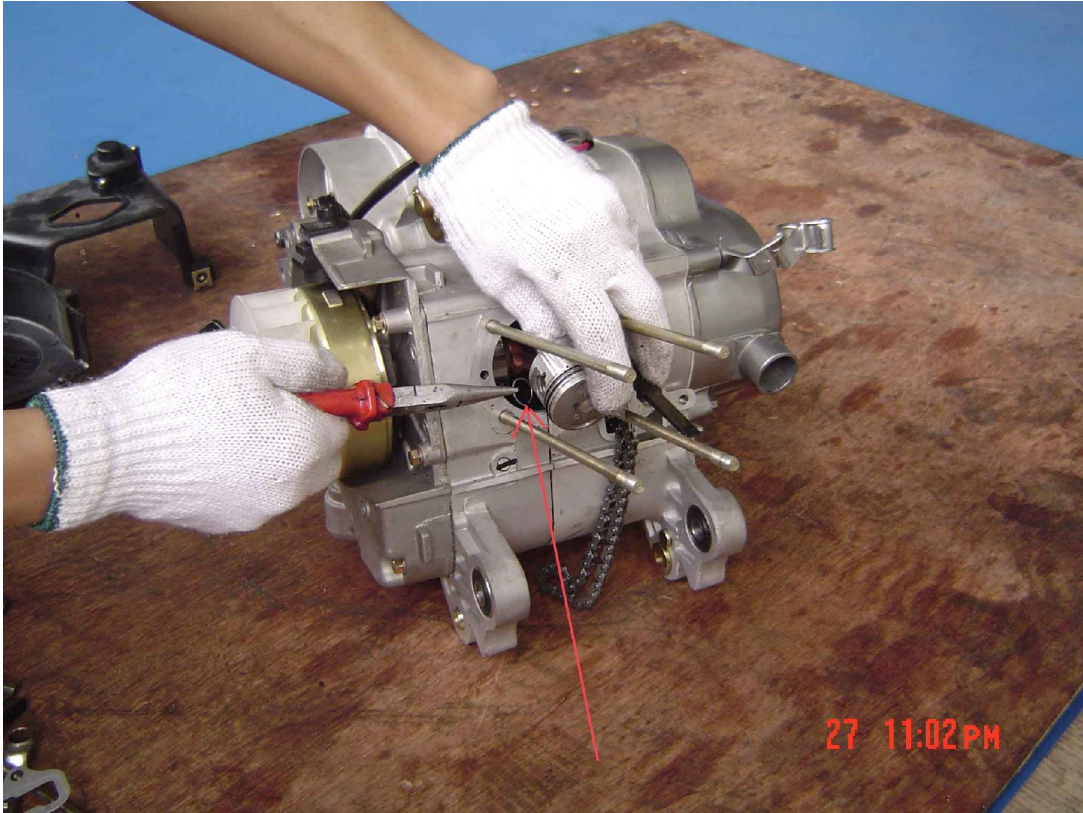

Fig. 15. Remove circlips and piston pin from the piston.

Don't throw out those circlips. My kit was missing one and I needed to re-use one of the old ones.

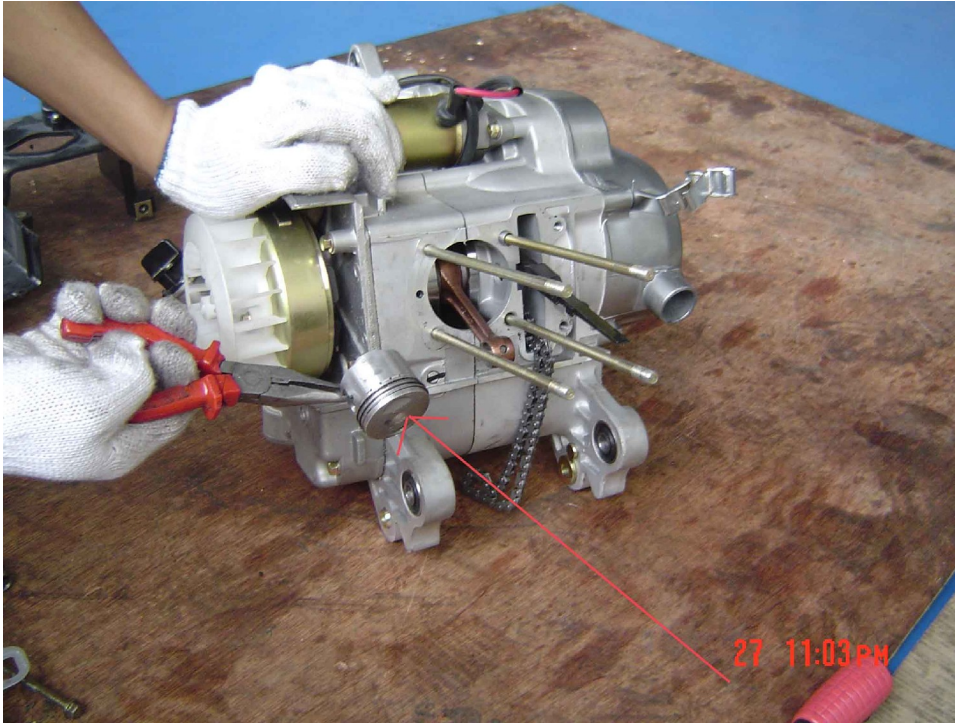

Fig. 16, remove the piston.

At this point you want to protect the engine by stuffing a clean dry rag into the opening

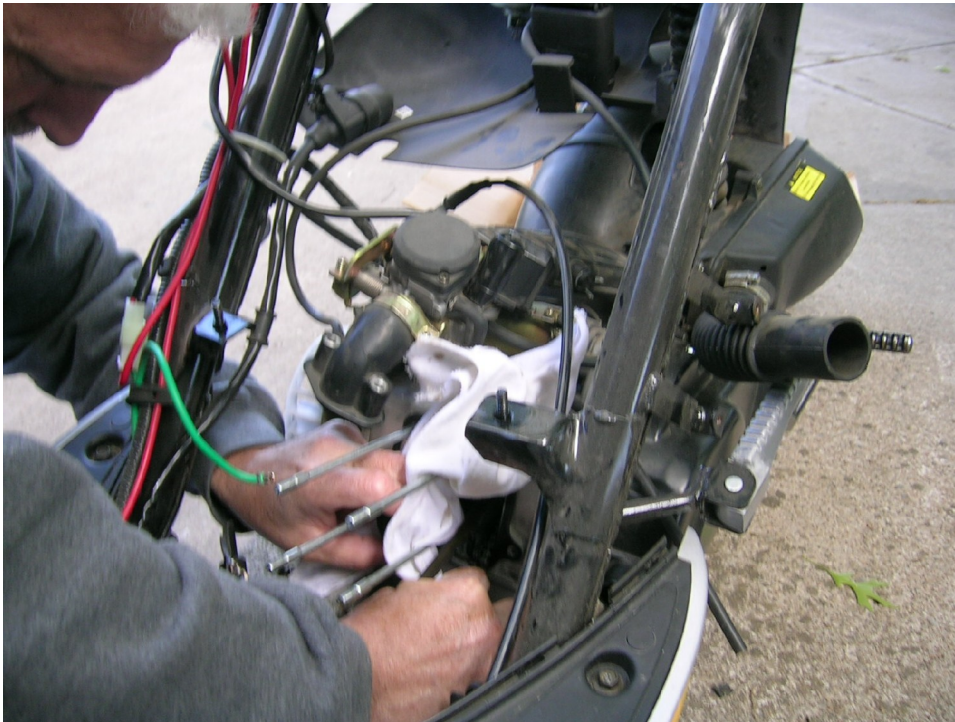
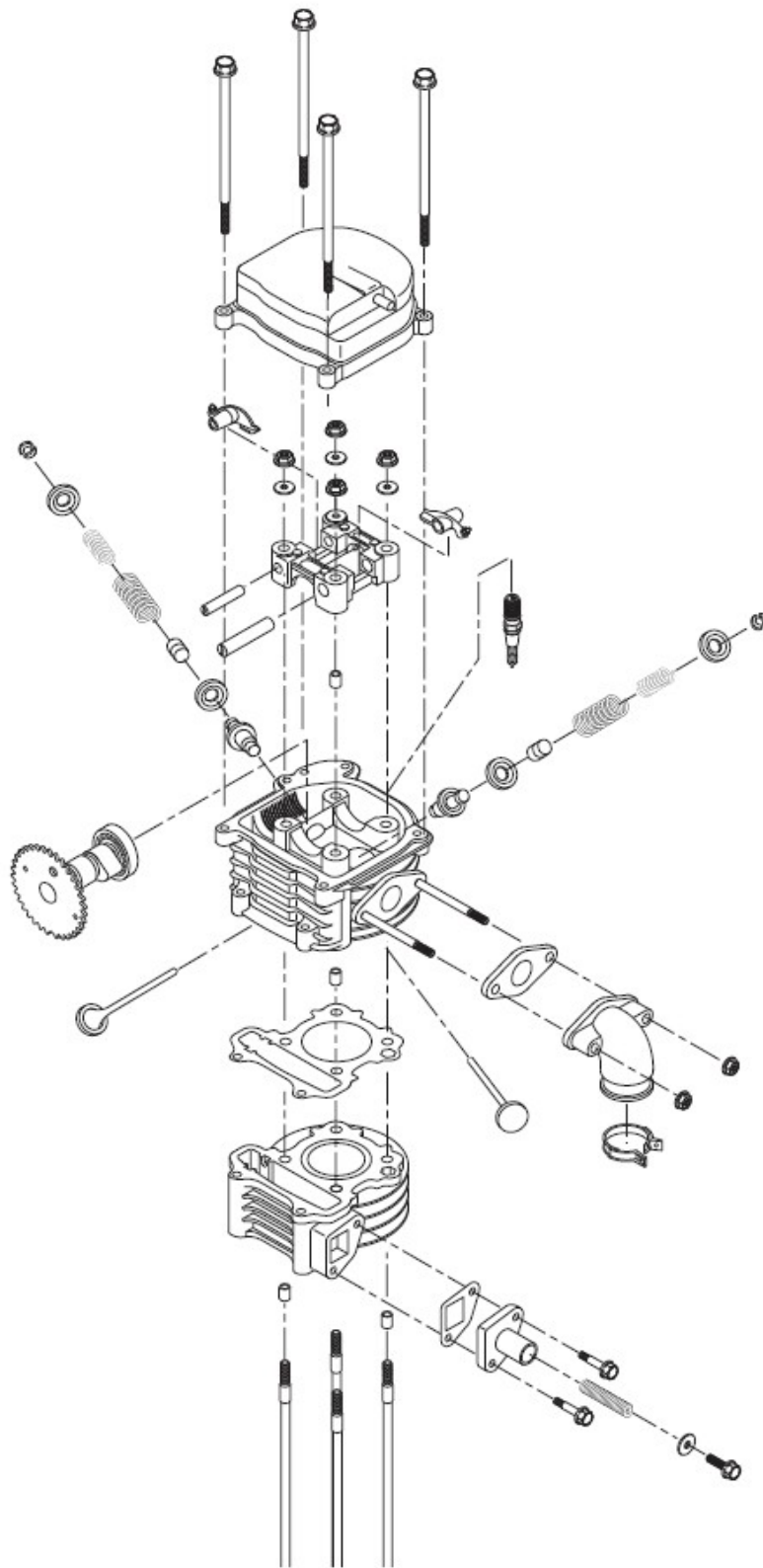
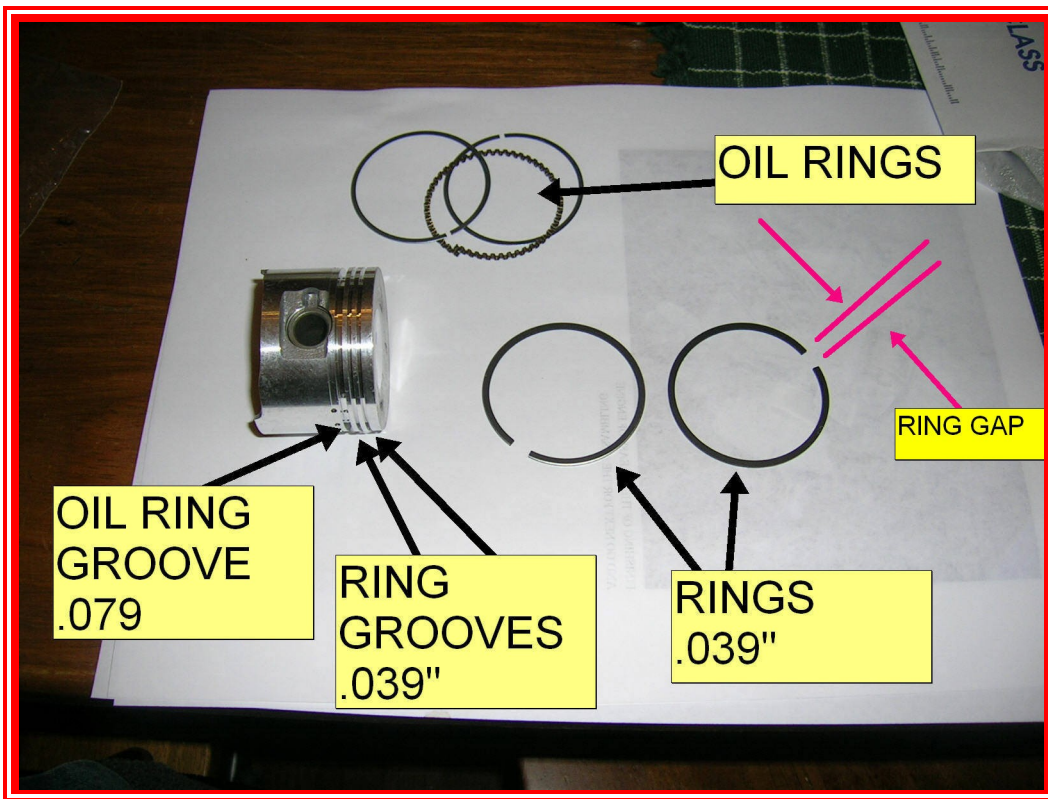

Fig. 17. Protect engine opening.

Now you've done it. It's all in pieces. I hope you can get it back together!



Top End Install for GY6 Part B



NOTE: Not all steps are included. Use a little common sense and install gaskets, washers, pins, nuts and bolts at the proper time. Hey, I can't do everything for you!

A word about the rings before we go any further. You should have five piston rings. The two thin rings along with the wavy ring are your oil rings. They will all need to fit into the wider groove on the lower side of the piston. This is no easy chore. These rings are brittle and you must be careful not to bend them too much installing them or they will break. The way to install these rings is as follows:

It is imperative that you make sure the rings are properly gapped before proceeding with the install. Mine happened to be gapped properly from the factory but that is not always the case. If the rings don't have enough gap, they will expand when heated and the ends will butt against each other and shatter. Too much gap and you will lose compression. I found several formulas on the net to figure what the ring gap should be. I don't have the formulas written down but I do have a note that I ended up setting my gap at .008". The following instructions were written by William Longyard in the Yahoo Geely Group and I quote here with his permission:

Gapping rings is not hard IF you GO SLOW.

- 1. Gently insert ring into cylinder bore.*
- 2. Bring piston (without any rings) up into cylinder so that it just touches the ring. Press the ring down so that it "seats" on top of the piston.*
- 3. With a feeler gauge measure the gap.*
- 4. If it is within spec do nothing.*
- 5. If it is too small reinsert the piston and slowly push the ring out of the cylinder. MOST RINGS ARE CAST IRON, THEY BREAK EASILY.*
- 6. Clamp a VERY thin file upright in a vise. Carefully with two hands JUST slightly open the ring gap so that the ends meet the file. Do a couple of strokes.*
- 7. RECHECK gap.*
- 8. Repeat until gap with within specs.*

I know this sounds like a PITA, but if you don't do it when the rings expand under heat, IF the ends touch each other the ring will instantly disintegrate. Most aftermarket rings are NOT properly gapped.

Two more points: Some people like to use ring expanders to install rings. Also, you can call a lawnmower shop and tell them the diameter of your piston and they can ballpark the right gap for you. Tell them whether it is two or four stroke.

*Good luck,
Bill Longyard*

Once you know you have your rings properly gapped, you can proceed with installing them on the piston. Lubricate the piston and rings lightly with oil. The wavy ring goes on first. This part is TRICKY, proceed with caution. Two pairs of hands is useful. The two thin rings go on either side of the wavy ring. The only way you will get these rings into this groove is to put the wavy ring in first, then you must approach the groove with each ring from its own direction. In other words, one thin ring from the top of the piston and one from the bottom. Keep at it until all three rings are fully in the groove.

The larger rings are next. One of them is designed for the top of the piston. The top one should have a mark or letter on one side of the ring. The mark should face up. Also, these rings are beveled and the bevel should face UP. Often the beveled edges are shiny.



Fig. 1. Rings finally in after many smokes, grunts and curses.

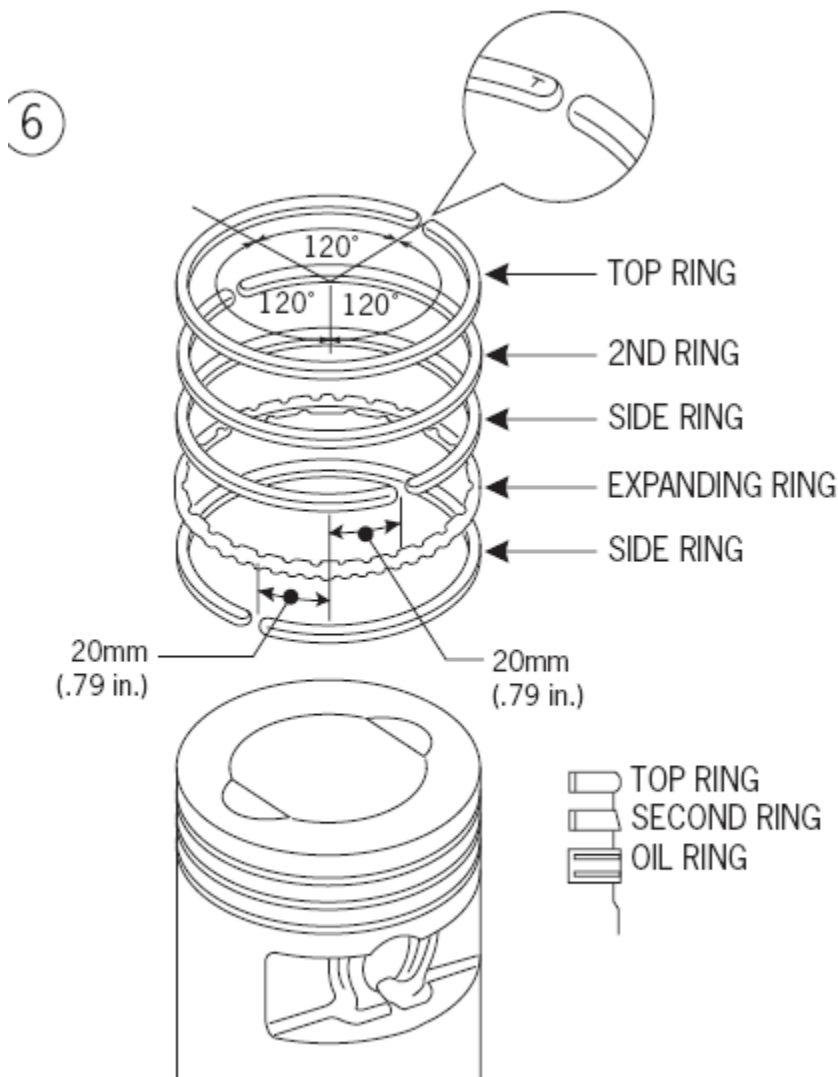
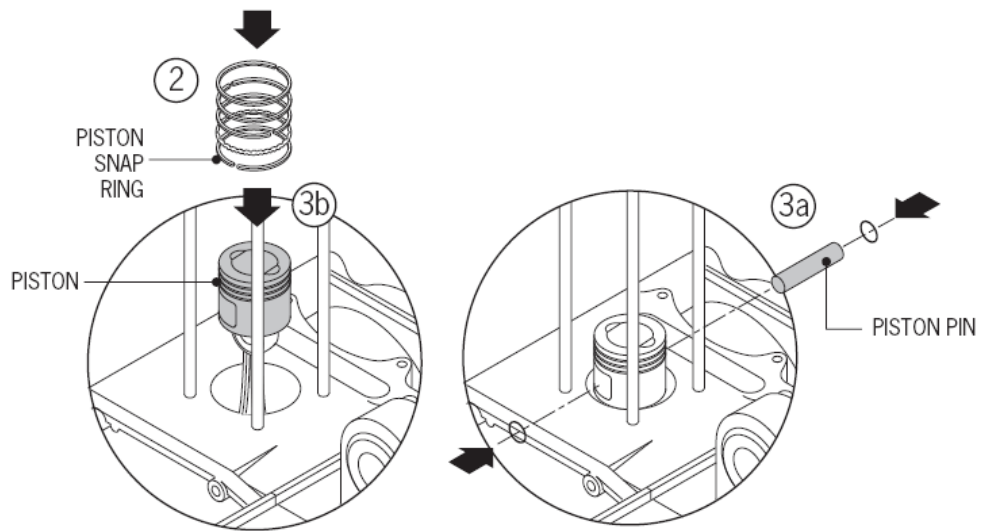
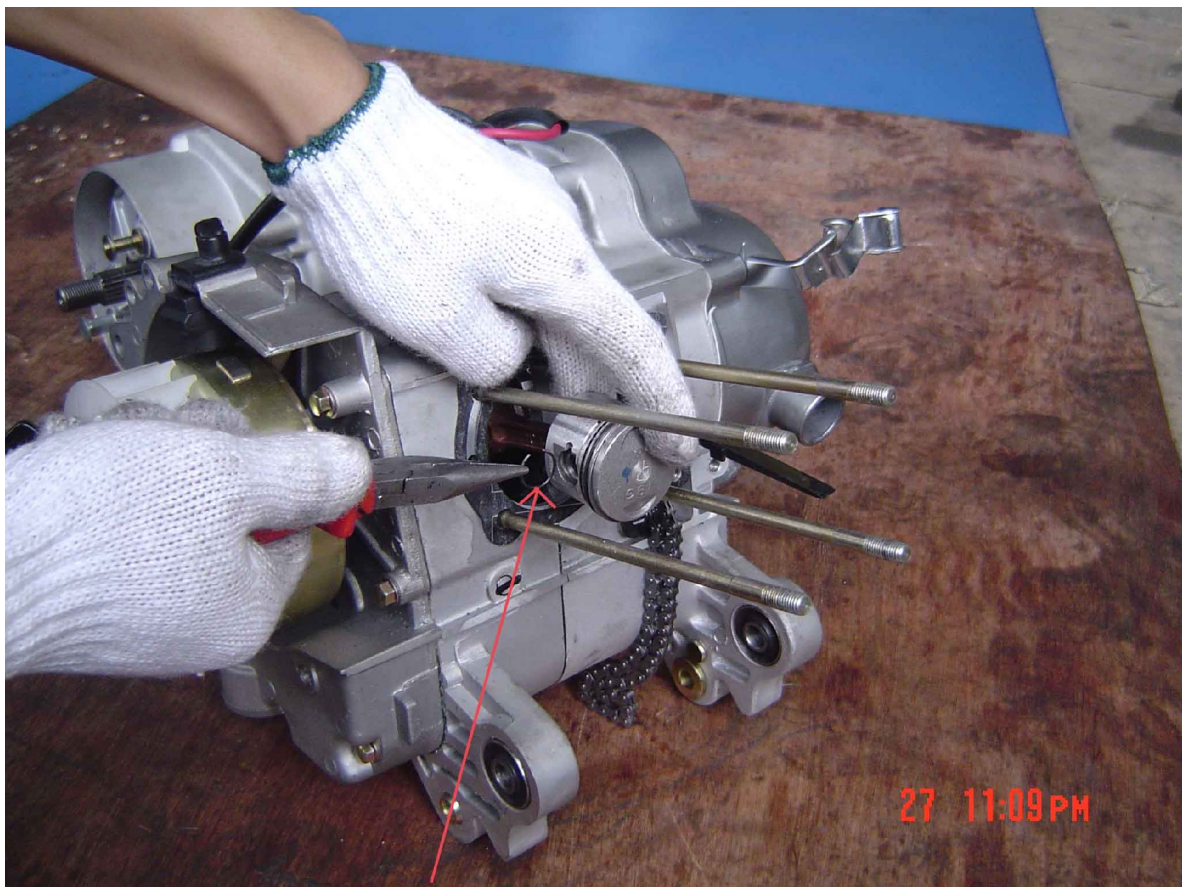

Fig. 2. Piston and Rings.

This illustration shows the rings with a 120degree gap. Most knowledgeable people I have spoken with recommend a 180degree gap with the ring gaps being perpendicular to the wrist pin. In other words, the ring gaps should NOT be on the side of the piston thrust as it rides the cylinder. Installing the rings is the most tedious part of the build and you must be patient and do it right. It's critical.



Figs. 3 a, b & c. Installation of Piston.



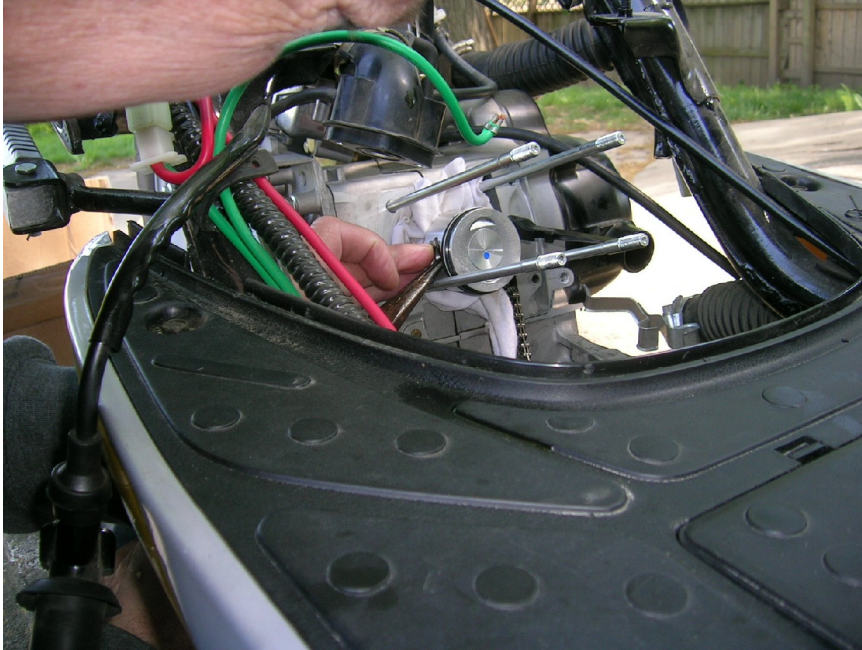

Install piston, pin with circlips.

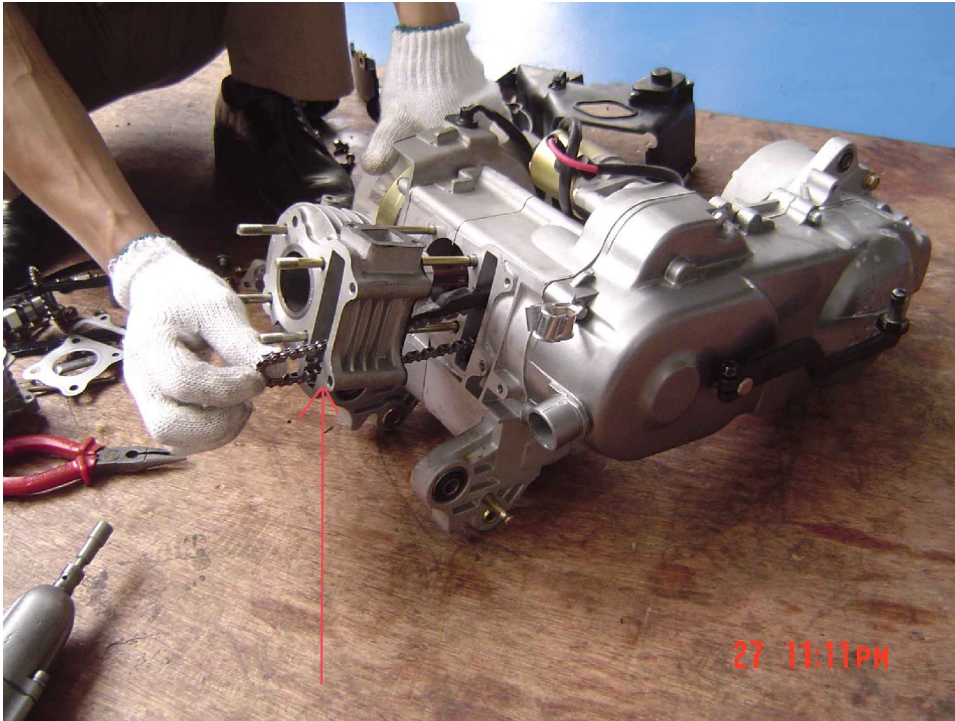

Fig. 4. Install the cylinder over the piston.

Most people use a ring compressor or even a hose clamp to keep the rings tight when sliding the cylinder on. Again, make sure everything is lightly lubricated.

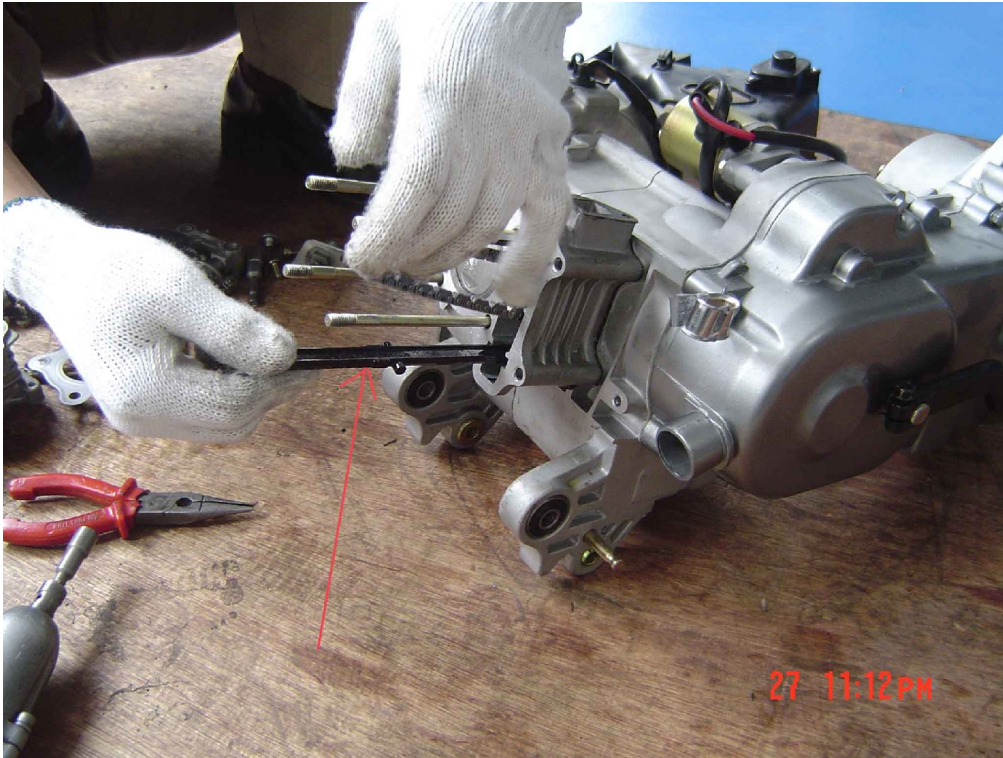

Fig. 5. Install the chain guide.

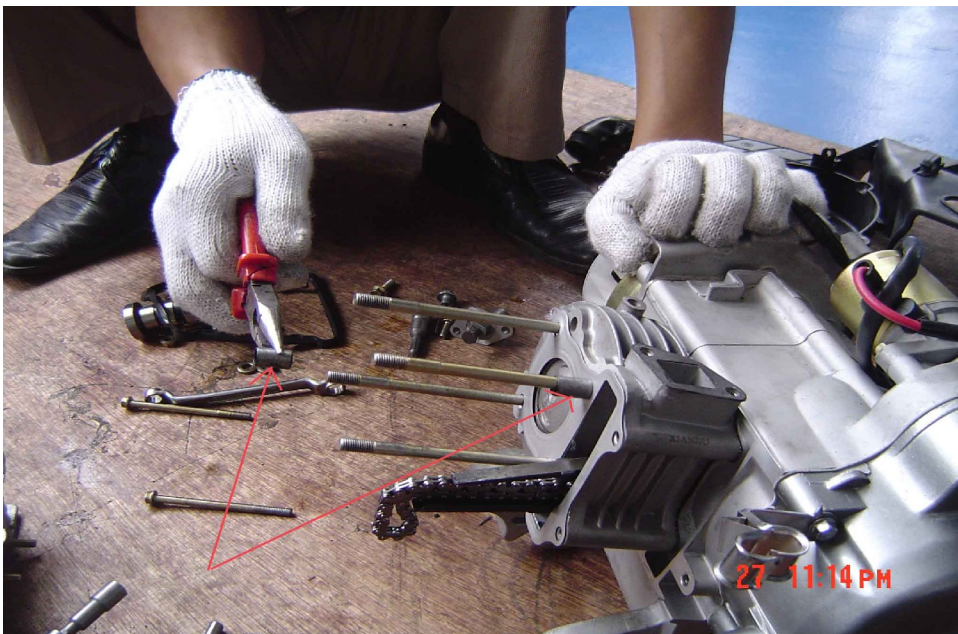

Fig. 6. Install two alignment pins.

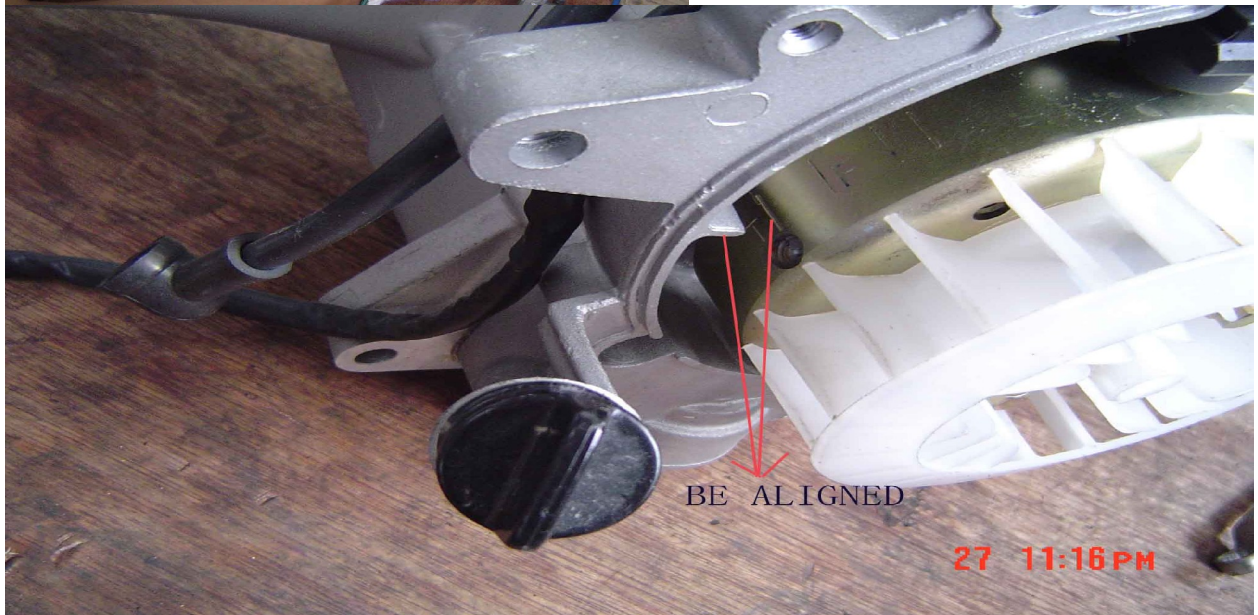
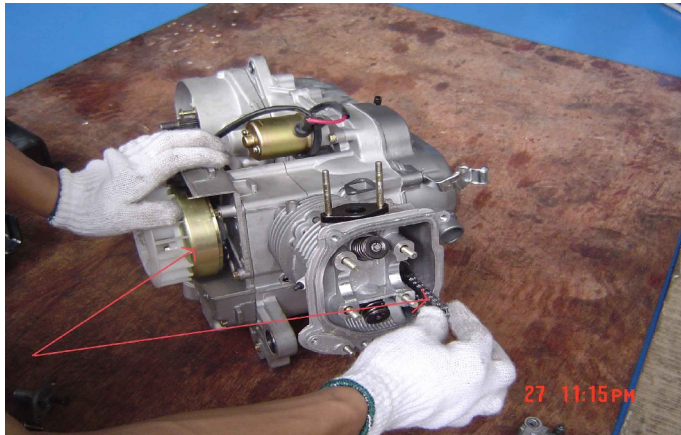

Fig 7. a & b. Install the cylinder head. Rotate the magneto and chain until the markings are lined up.



Fig. 8. Install the camshaft.



Fig. 9 a & b. Note the lines must be even with the edge of the head.

ed studs.

imshaft
nut into
ighten
t and bolt

:
ed nut:
ft lbs

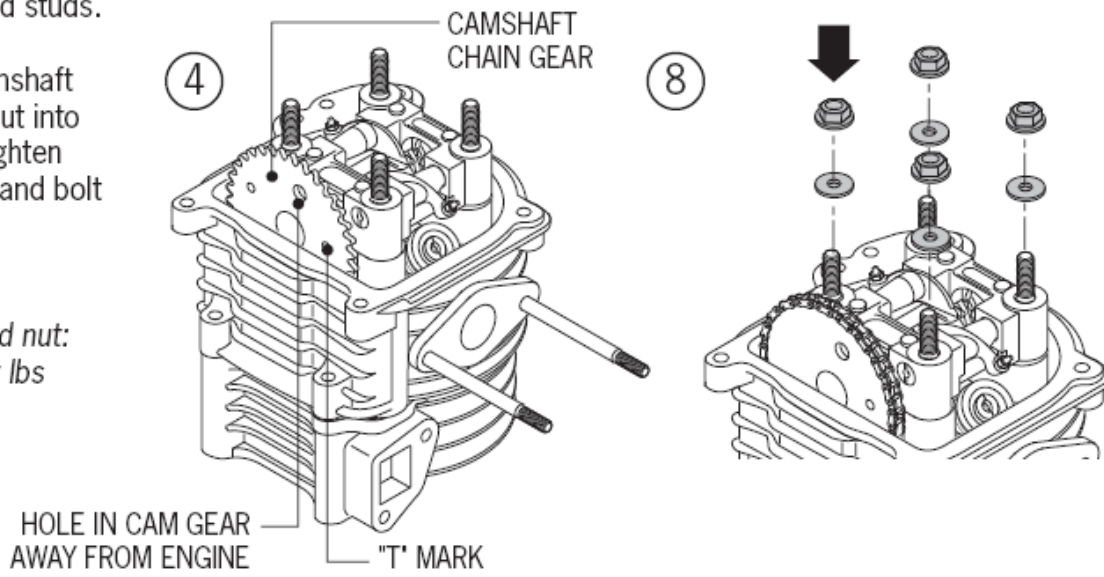

Fig. 10. Install alignment pins

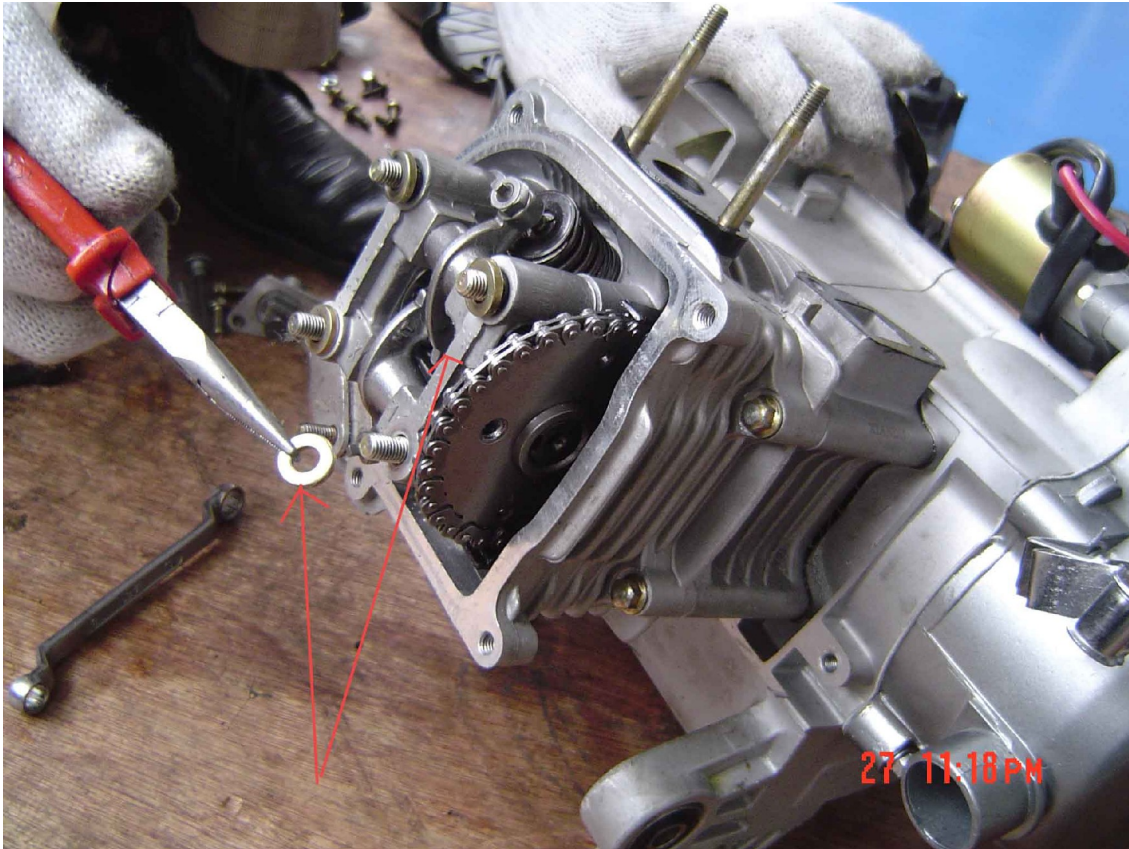

Fig. 11. Install valve seat and washers



Fig. 12. Install chain tension assembly.

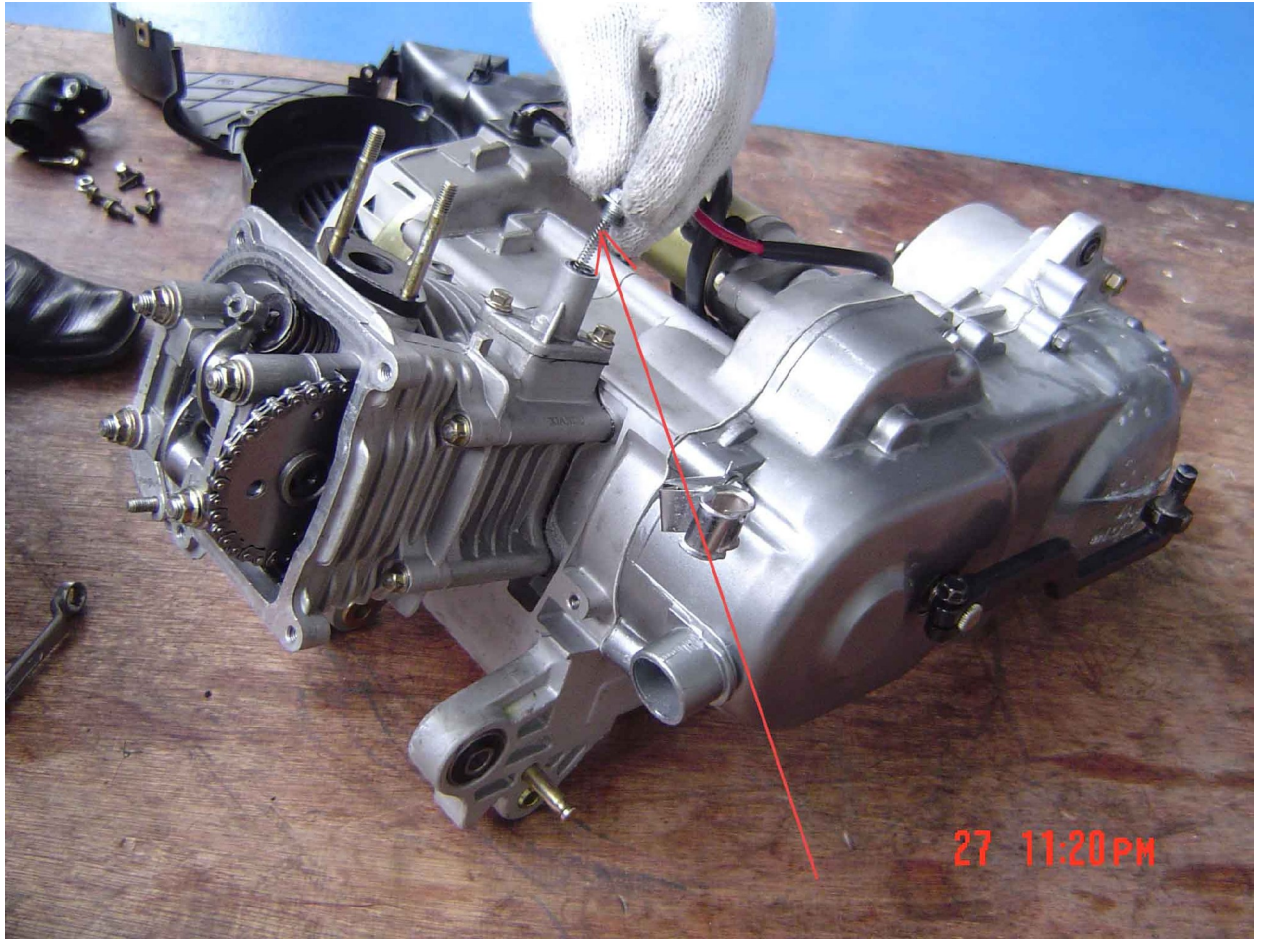

Fig. 12b. Install chain tension.

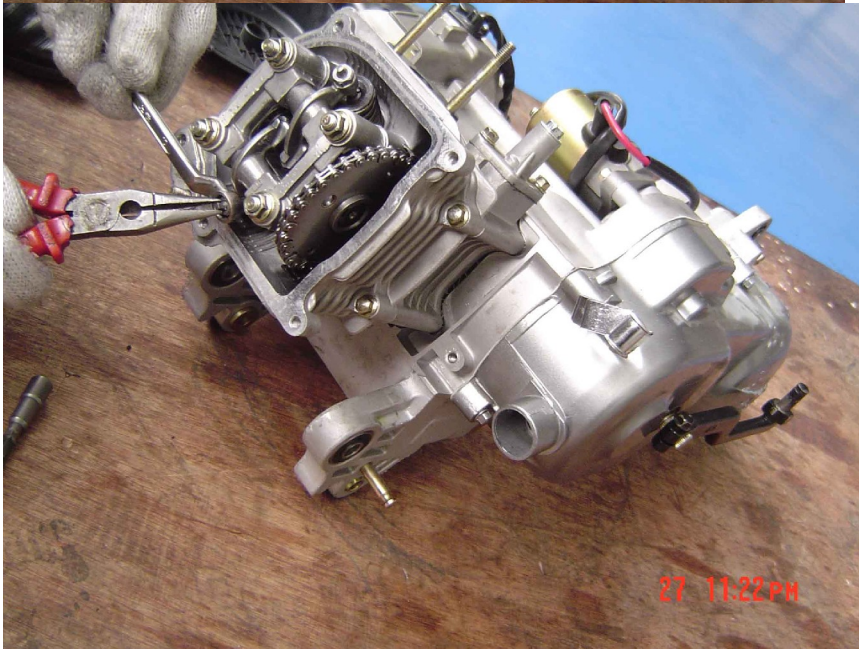
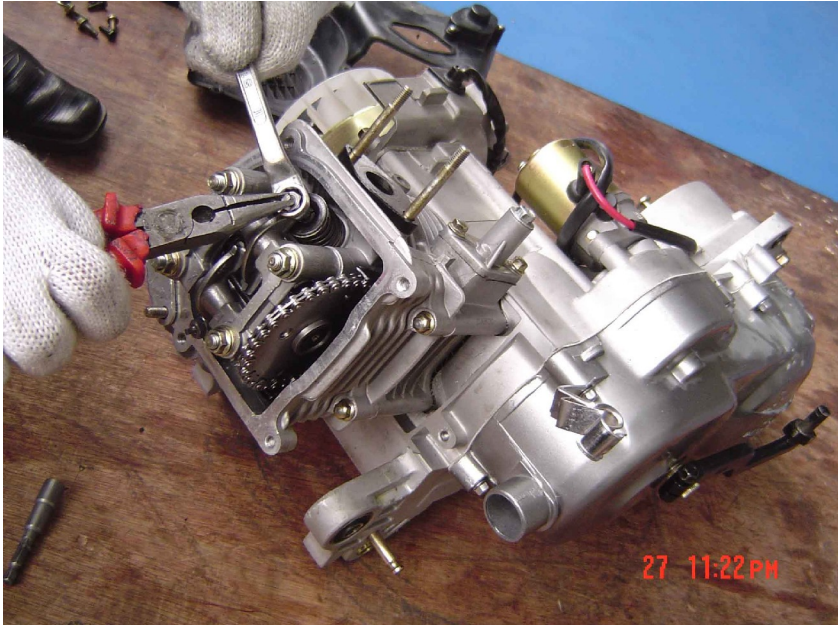

Fig 13 a & b. Adjust valve clearance. Use a feeler guage.

Inlet valve .008" Outlet valve .010. Others have reported better results with a little wider clearance.

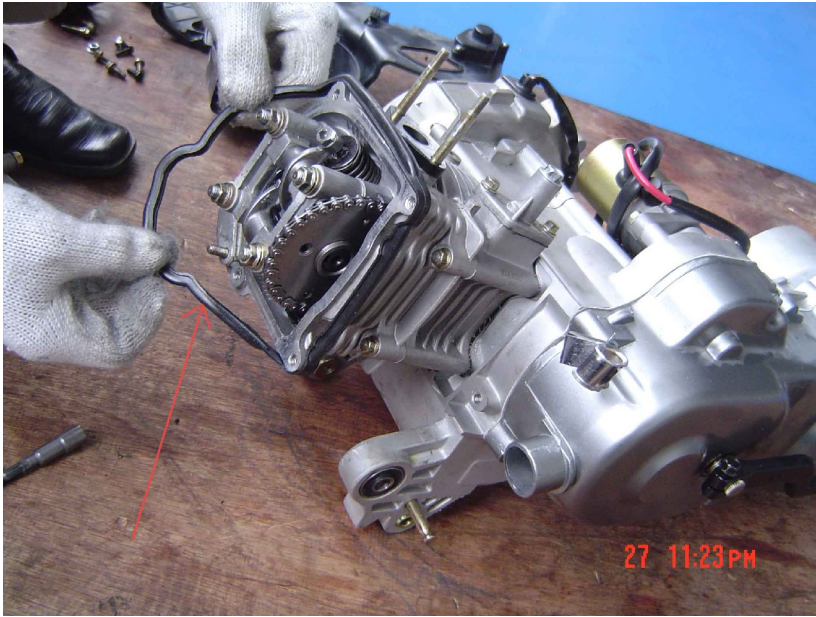

Fig. 14. Install gasket

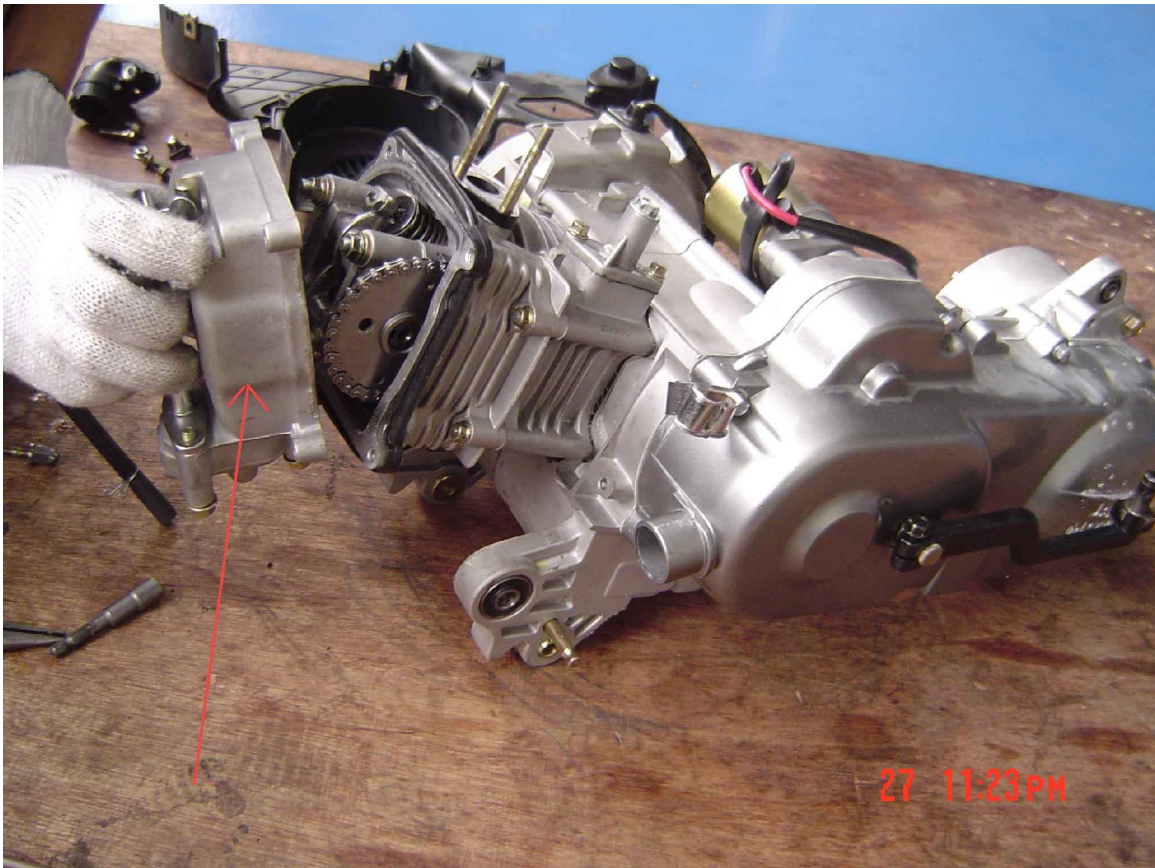

Fig. 15. Install head cover.

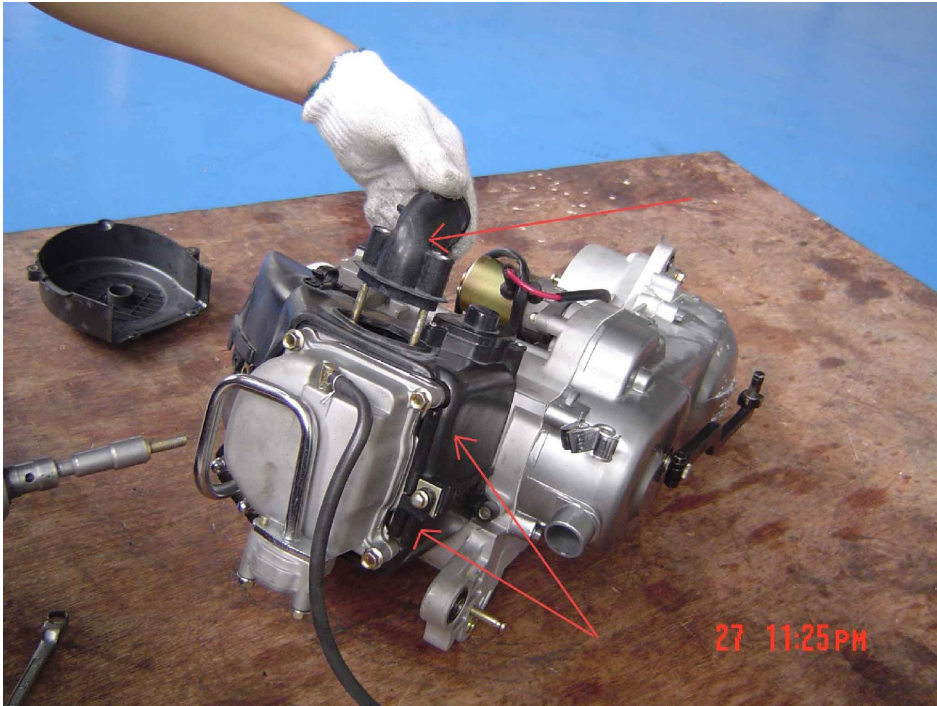

Fig. 16. Install carb inlet tube.



Fig. 17. Install fan cover, wires etc.

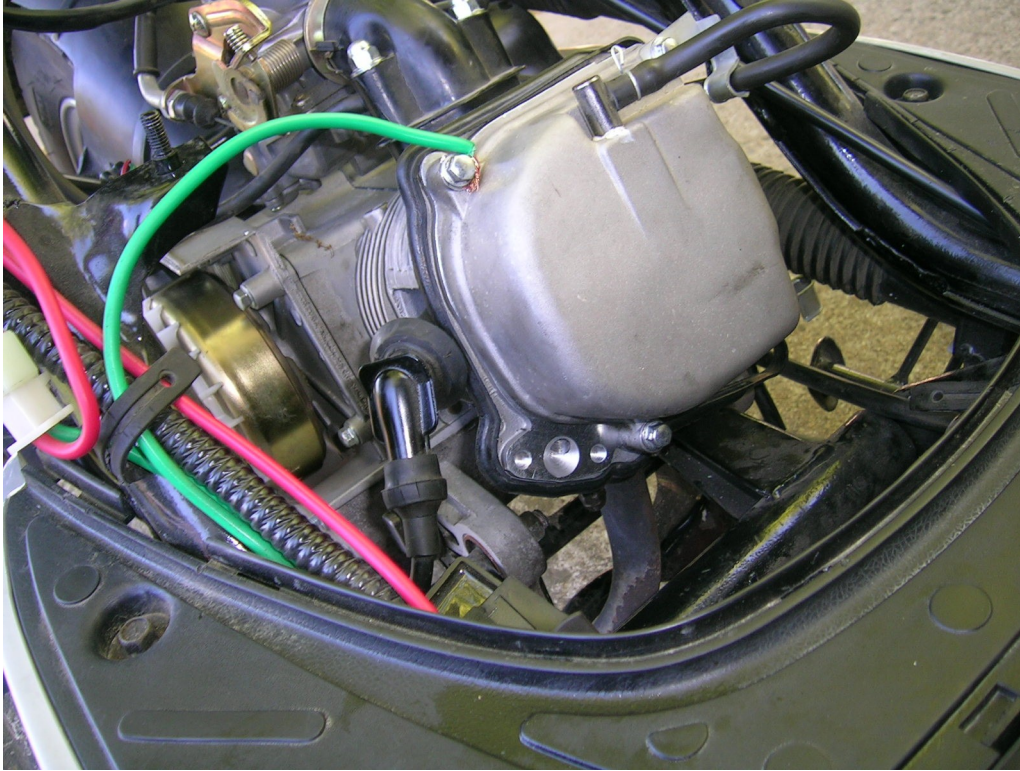

Fig. 18. Installation complete. Start her up and hope for the best.